



PIVOT
CYCLES

SHUTTLE SL

PIVOT SHUTTLE SL

Original Operational Instructions

This manual is intended to provide you with the information needed to get you on the trail, walk you through the steps necessary to set up all the components, and become familiar with the FAZUA E-bike System. This document contains some helpful diagrams and reference material to make sure you have everything necessary to maintain your Shuttle SL and enjoy it to the fullest.



TABLE OF CONTENTS		PAGE
1. Quick Start Guide		1
- Suspension/Tire Set-up		1
- Adjusting Saddle Height		1
- Charging the Battery		1
- Powering the System ON and OFF		1
- Ring Control and LED Hub Functions		1
2. Bike Set-up		2
- Recommended Tire Pressure		2
- Setting Sag		3
- Setting Compression Damping on the Fox Float X & DPS		4
- Setting Rebound Damping on the Fox Float X & DPS		4
- Setting Air Pressure on the Fox 36 & 34 Forks		5
- Setting Compression Damping on the Fox 36 & 34 Forks		5
- Setting Rebound Damping on the Fox 36 & 34 Forks		5
3. Charging		6
- Charging the Battery		6
4. FAZUA System Basics		6
- Control Elements: Ring Control & LED Hub		6
- Powering the System ON and OFF		7
- Support Modes		7
- Boost Mode		8
- Walk Assist Mode		8
- LED Hub USB Port		8
- Speed Sensor		8
- Support Characteristics		9
- FAZUA App Navigation		10
- FAZUA Toolbox Software		11
- Connect to the FAZUA Toolbox		11
- Customize Assistance Profile		12
- Setting Custom Assistance Profiles		13
- Saving Custom Assistance Profiles		13
- Exporting & Importing Custom Assistance Profiles		13
- Update System Software		13
5. Troubleshooting		14
- Troubleshooting Table		14
6. Schematics		15
- FAZUA Schematic		15
- Small Parts Schematic		16
- Wiring Diagrams		17
Contents continues on the next page		



TABLE OF CONTENTS (Cont')		PAGE
7. Third Party Compatibility		18
- Compatible Devices		18
- Garmin Pairing		18
8. Warnings		19
- Bicycle Safety		19
- Improper Use Hazards		19
- Health Hazards		20
- Potential Damage Hazards		20
9. Additional Information		21
- FAZUA Ride 60 Drive System		21
- Pivot Shuttle SL		21
- Conformity		21
- Sources		21

TECHNICAL DATA ON THE DRIVE UNIT	
Article Number	10A101000A/10A101100A
Continuous rated power	250W
(Mechanical) power, max.	450W
Nominal voltage	43.2 V
Support torque, max.	60 Nm
Pedaling cadence (range)	55-125 rpm
Protection type	IP54
Weight, approx.	4.3 lbs (1.95 kg)
Operating temperature	23 °F to 113 °F (-5 °C to +45 °C) ambient temperature

TECHNICAL DATA ON THE BATTERY	
Model Designation	FAZUA ENERGY 430 fix
Weight, approx.	4.85 lbs (2.2kg)
Operating temperature	23 °F to 104 °F (-5 °C to +40 °C) ambient temperature
Storage temperature (< 1 month)	5 °F to 140 °F (-15 °C to +60 °C)
Storage temperature (> 1 month)	5 °F to 77 °F (-15 °C to +25 °C)

TECHNICAL DATA ON THE CHARGER	
Model designation	CHARGER 3A (Model STC-8207LD)
Nominal input voltage	100-240 V AC
Frequency	47-63 Hz
Charging current	3 A
Charging time, approx.	3.5 h
Protection class	2 [symbol: ]
Protection type	IP54 (when plugged in)
Weight, approx.	1.32 lbs (0.6 kg)
Operating temperature	32 °F to 95 °F (0 °C to +35 °C)
Storage temperature	32 °F to 113 °F (0 °C to +45 °C)





Suspension/Tire Set-up

Shock Air Pressure (by Body Weight) <i>*Always check sag</i>	Body Weight in [kg] to [bar]	$0.15 \times \text{Body Weight [kg]} = [\text{bar}]$
	Body Weight in [kg] to [psi]	$2.2 \times \text{Body Weight [kg]} = [\text{psi}]$
	Body Weight in [lbs] to [bar]	$0.07 \times \text{Body Weight [lbs]} = [\text{bar}]$
	Body Weight in [lbs] to [psi]	$\text{Body Weight [lbs]} = \text{Body Weight in [psi]}$
Shock Compression Damping		8 clicks in from OPEN*
Shock Rebound Damping		6 clicks in from OPEN
Fork Air Pressure		75 [psi] / 5.17 [bar]
Fork Compression Damping		HSC: 2 clicks in from OPEN* ; LSC: 5 clicks in from OPEN
Fork Rebound Damping		HSR: 3 clicks in from OPEN* ; LSR: 7 clicks in from OPEN
Front Tire Pressure		23 [psi] / 1.58 [bar]
Rear Tire Pressure		28 [psi] / 1.93 [bar]

** These Adjustments are not available on all builds.*

Adjusting Saddle Height

1. Use a 2mm hex wrench to loosen the drive side cable port cap securing the dropper post housing.
2. Using a 4mm hex wrench, loosen the seat post clamp bolt and raise/lower the saddle to the preferred height.
3. Using a 4mm hex wrench, tighten the seat post clamp bolt to 5 [Nm].
4. Tighten the cable port cap screw with a 2mm hex wrench to secure the dropper post housing.

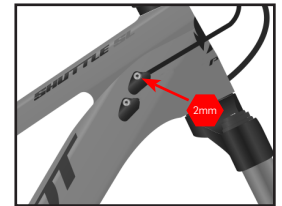

Charging the Battery

NOTE: The battery does not come fully charged and must be completely charged before the first use.

1. Prepare the charger by plugging the power cable into the power inverter.
2. Open the magnetic cover over the bikes charging port.
3. Plug the power cable into the bikes charging port.
4. Connect the charger to an outlet.

To ensure a full charge, wait until the LED on the charger switches from red to green.

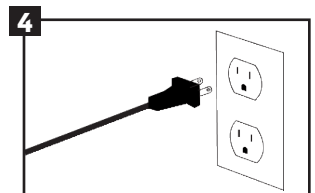
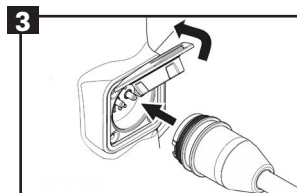
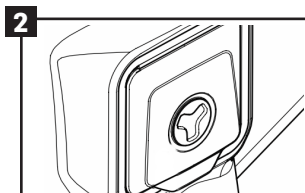
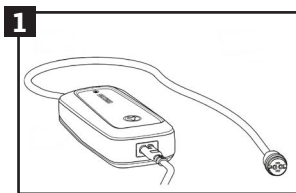

Powering the System ON and OFF

NOTE: The system will automatically turn itself off after extended non-activity.

1. Locate the ring controller on the handlebar.
2. Power the system on by pressing up on the controller for at least 2 seconds. The five LEDs on the LED Hub will illuminate.
3. Once the power-up sequence is complete, the lights will illuminate to indicate the battery charge level.
(1 LED = 0-20%, 2 LEDs = 20-40%, 3 LEDs = 40-60%, 4 LEDs = 60-80%, 5 LEDs = 80-100%)
4. To turn off the system, press and hold the ring controller down for 1 second.

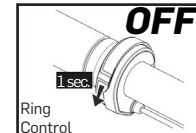
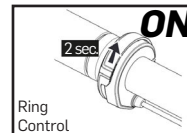

Changing Levels of Support

Increase support by briefly pushing up on the switch. To decrease support briefly push down on the switch. The 5 LEDs in the LED Hub on the top tube will illuminate in different colors for each support mode.

- White LEDs** No Support- as if you were riding a conventional bike.
- Green LEDs** Breeze- low but effective support for maximum range.
- Blue LEDs** River- reliable support for most applications.
- Pink LEDs** Rocket- maximum support for very demanding terrain.

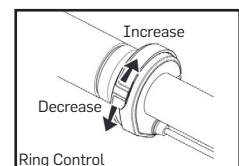
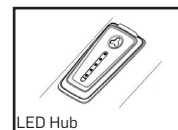



Recommended Tire Pressure

- Tire pressure is an important factor on having the bike ride properly. If the tire pressure is too high, the tire will not conform to ground, reducing traction. If the tire pressure is too low, the tire could pinch flat.
- It is important to have an accurate pressure gauge when setting tire pressure; preferably a digital gauge with a 0.03 [bar] (0.5 [psi]) accuracy.
- The recommended tire pressure will vary slightly based on rider weight, riding style, and terrain.
- Some riders may find it helpful to start a ride at a slightly higher pressure than recommended and let out a little air throughout the course of the ride until you find your ideal riding tire pressure.

RECOMMENDED TIRE PRESSURE	
FRONT	REAR
1.58 [bar] / 23 [psi]	1.93 [bar] / 28 [psi]

Setting Sag on FOX Air Shocks

1. Always set sag with the blue compression lever to the open position. (fig. 1)
2. If your shock has additional compression and rebound adjustments ensure they are adjusted to be fully open, compression to the softest setting, and rebound to its fastest setting. This is done by turning them fully counter-clockwise.
3. If it is not installed already, attach the sag indicator to the bottom of the shock body using the provided zip-tie and carefully cut the excess.(fig. 2)
4. Find a level surface and something to steady yourself while mounted on the bike so you can be on the pedals in a seated position. It may be easier to have a partner hold your bike steady from the front, by holding the handlebars while you are in your riding position.
5. While standing on the pedals, sit down hard into the saddle to cycle the suspension well into the stroke. This will ensure the bike comes to rest at the natural sag setting with the rider in the saddle.
6. While in the saddle and not moving, slide the O-ring up into position against the air can. (fig. 3)
7. Once the O-ring is set in place, slowly step off the bike so as not to move the O-ring.
8. Make adjustments to the sag by removing or adding air so that steps 4-7 result in the O-ring lining up with the red line on the sag indicator (fig. 4). When adjusting air pressure in the shock, cycle the shock before re-checking sag, so the large Evol negative air chamber equalizes pressure with the main chamber each time air is added or removed. You can do this by pushing down on the saddle several times to compress the shock past the sag point.

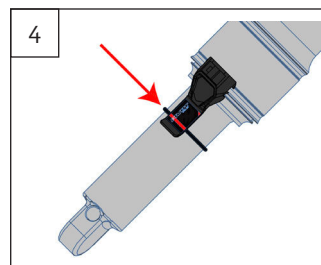
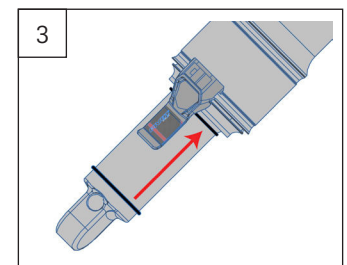
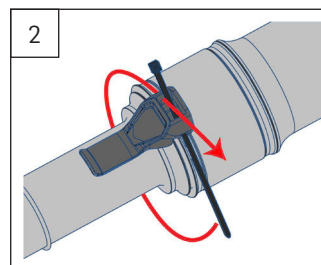
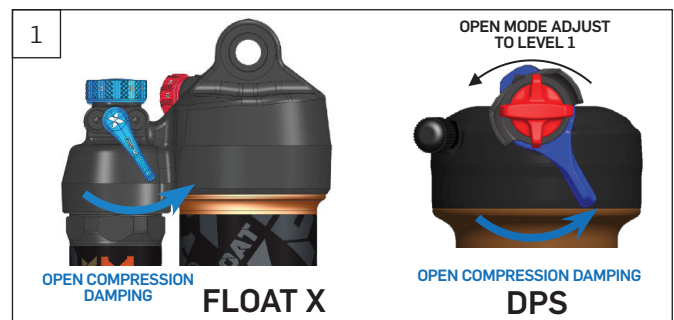

WARNING: Make sure the sag indicator does not contact the frame or linkage through the suspension cycle. Otherwise, the indicator may break while riding.





Setting Compression Damping on the Fox Float X

Some Float X shocks features a blue low speed compression adjustment knob, which can be used to fine tune the open mode of the compression damping. This knob offers 10 additional fine tune adjustment settings to the open mode. Turning the knob clockwise will increase low speed compression damping. Turning the knob counter-clockwise will decrease low speed compression damping. You can experiment with all of these options to find the setting that provides the best compression support and plush feel for your weight and riding style. For a rider close to 100 lbs we recommend having the compression fully open, by having the knob turned fully counter-clockwise. For riders 200 lbs we like to start at 3 clicks in from full closed as a good baseline setting. If the rider's weight is less than 200 lbs, open up compression damping 1 click counter-clockwise for every 10 lbs less. For every 10 lbs over 200 lbs we recommend increasing compression damping by 1 click clockwise.



LOW SPEED COMPRESSION KNOB

Using the Two-Position Lever on the Fox Float X

Float X shocks feature a two-position lever for on-the-fly adjustment between fully open and firm for climbing. The firm setting is best suited for long fire road climbs and smooth XC courses.



2 POSITION LEVER

Setting Compression Damping on the Fox DPS

Because all dw-link® equipped Pivot bikes pedal so efficiently, we use the compression lever as a tuning tool for rider weight and compression support. All bikes can be run with the blue lever in full open and perform very well. On Float DPS shocks, the lever is turned towards the opposite side of the air valve. Lighter riders under 160 lbs will generally run in the full open position most of the time. Riders in the 190 lbs+ range and more aggressive riders who like the feel of more mid-stroke support will generally prefer the middle setting. The firm setting is for long fire road climbs, and smooth XC race courses where a more locked out feel is desired.

All Factory Series Float DPS shocks feature three additional options that affect the open setting via the black knob. This knob needs to be lifted slightly to turn to one of the three designated options. #1 is the most open, or least amount of compression damping, and #3 is the firmest (but still slightly less firm than the middle position of the blue lever). You can experiment with all of these options to find the setting that provides the best compression support and plush feel for your weight and riding style. Other than running in the full firm mode on rocky descents, all settings are designed to work well in a wide variety of terrain and rider weights.



OPEN MODE ADJUST





Setting Rebound Damping on the Fox Shocks

- Rebound is set from the most open, fully counter-clockwise, position.
- The rebound setting is determined by the air pressure in the shock.
- Refer to the table below for the suggested rebound setting. The number in the chart refers to how many clicks in clockwise from the open setting the rebound should be set. Fox sets rebound from the closed position, so that has been provided in the table in parentheses.



DPS REBOUND KNOB



FLOAT X REBOUND KNOB

AIR PRESSURE		SUGGESTED REBOUND	SUGGESTED REBOUND
[bar]	[psi]	SETTING FLOAT X	SETTING FLOAT DPS
< 8.3	<120	1 (9)	OPEN-3 (Open-11)
8.3 - 9.7	120-140	2 (8)	4 (10)
9.7 - 11	140-160	3 (7)	5 (9)
11 - 12.4	160-180	4 (6)	6 (8)
12.4 - 13.8	180-200	5 (5)	7 (7)
13.8 - 15.2	200-220	6 (4)	8 (6)
15.2 - 16.5	220-240	7 (3)	9 (5)
16.5 - 17.9	240-260	8 (2)	10 (4)
17.9 - 19.3	260-280	9 (1)	11 (3)
19.3 - 20.7	280-300	CLOSED	CLOSED

Clicks from OPEN (Clicks from CLOSED)

Setting Air Pressure on the Fox 36 & 34 Forks

- Fox recommends setting sag between 15% and 20% of the total fork travel. The proper sag measurement for 140mm travel Fox 34 Forks is 21mm- 28.0mm. For 150mm travel Fox 36 forks the proper sag measurement is 22.5mm-30mm.
- The air pressure in the Fox 36 or the Fox 34 should not exceed 120 psi (8.3 bar).
- To achieve the proper sag, reference the chart below for an initial starting point.
- Through Pivot's testing, we have found that for some riders, the Fox recommended pressures are too high and limit the ability to achieve full fork travel. The below chart is adjusted to reflect our recommended pressures.

RIDER WEIGHT		FOX 36	FOX 34
[kg]	[lbs]	AIR PRESSURE	AIR PRESSURE
55 - 59	120 - 130	58 [psi] / 4.0 [bar]	50 [psi] / 3.4 [bar]
59 - 64	130 - 140	62 [psi] / 4.3 [bar]	54 [psi] / 3.7 [bar]
64 - 68	140 - 150	66 [psi] / 4.6 [bar]	58 [psi] / 4.0 [bar]
68 - 73	150 - 160	70 [psi] / 4.8 [bar]	63 [psi] / 4.3 [bar]
73 - 77	160 - 170	74 [psi] / 5.1 [bar]	68 [psi] / 4.7 [bar]
77 - 82	170 - 180	78 [psi] / 5.4 [bar]	72 [psi] / 5.0 [bar]
82 - 86	180 - 190	82 [psi] / 5.7 [bar]	77 [psi] / 5.3 [bar]
86 - 91	190 - 200	86 [psi] / 5.9 [bar]	82 [psi] / 5.7 [bar]
91 - 95	200 - 210	89 [psi] / 6.1 [bar]	86 [psi] / 5.9 [bar]
95 - 100	210 - 220	94 [psi] / 6.5 [bar]	91 [psi] / 6.3 [bar]
100 - 105	220 - 230	99 [psi] / 6.8 [bar]	96 [psi] / 6.6 [bar]
105 - 109	230 - 240	105 [psi] / 7.2 [bar]	100 [psi] / 6.9 [bar]
109 - 114	240 - 250	109 [psi] / 7.5 [bar]	105 [psi] / 7.2 [bar]



Setting Compression Damping on the Fox 36 GRIP 2 Fork

- To set compression, start from the open (or fastest) position by turning the *black* (LSC) dial & *blue* (HSC) dial counter-clockwise until they stop clicking.
- A good starting point for most riders is to turn the *black* (LSC) dial clockwise 5 clicks & turn the *blue* (HSC) dial clockwise 2 clicks.
- The recommended starting points may need to be adjusted based on rider weight. Lighter riders may prefer less compression damping (fewer clicks from open).



GRIP2 Compression Knob

Setting Compression Damping on the Fox 36 GRIP Fork

- We always start with the lever in the full open position. Most riders will not need to make any changes from this position.
- However, if you do need more compression support, the lever will provide a low speed compression adjustment until the lever is turned halfway.
- The second half of the lever adjustment affects the high speed compression circuit. Of course, fully closed provides a nearly locked out feel for climbing.



GRIP Compression Knob

Setting Compression Damping on the Fox 34

- The Fit 4 damper features a *blue* 3 position compression adjustment lever. These settings are open, medium, and firm.
- The black inner dial adjusts the low speed compression damping that affects the firmness of the suspension (compression damping) in the fully open position. We set compression from the most open or fastest position, so start by turning the black compression inner dial counter-clockwise all the way out.
- Turn black dial clockwise in 2-8 clicks in (depending on rider weight). Most riders should feel comfortable with 5 clicks in as a starting point. A rider under 120lbs would start with 2 clicks in.



FIT4 Compression Knob & Open Mode Adjust

Setting Rebound Damping on Fox Forks

- Start from the open (or fastest) position by turning the *red* rebound dial(s) on the bottom of the right fork leg counter-clockwise until it stops clicking. On the Fox 36 these dial(s) are found under a protective cover.
- Refer to the chart below for the recommended settings when setting rebound. Fox clicks are in parentheses.

RIDER WEIGHT	FOX 36 SUGGESTED REBOUND	FOX 34 SUGGESTED REBOUND
	LSR / HSR <small>*HSR not available on all builds</small>	LSR Only
120-130 [lbs]	3 / Open (12 / 10)	Open (14)
130-140 [lbs]	4 / Open (11 / 10)	1 (13)
140-150 [lbs]	5 / 1 (10 / 9)	2 (12)
150-160 [lbs]	6 / 2 (9 / 8)	3 (11)
160-170 [lbs]	7 / 3 (8 / 7)	5 (9)
170-180 [lbs]	8 / 4 (7 / 6)	6 (8)
180-190 [lbs]	8 / 4 (7 / 6)	7 (7)
190-200 [lbs]	9 / 5 (6 / 5)	8 (6)
200-210 [lbs]	9 / 5 (6 / 5)	9 (5)
210-220 [lbs]	10 / 6 (5 / 4)	10 (4)
220-230 [lbs]	11 / 7 (4 / 3)	11 (3)
230-240 [lbs]	11 / 7 (4 / 3)	12 (2)
240-250 [lbs]	12 / 8 (3 / 2)	13 (1)

Clicks from OPEN (Clicks from CLOSED)

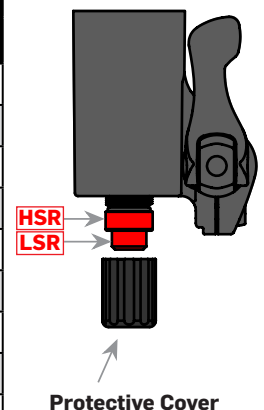



Charging the Battery

NOTE: The battery does not come fully charged and must be completely charged before the first use.

1. Prepare the charger by plugging the power cable into the power inverter.
2. Open the magnetic cover over the bikes charging port.
3. Plug the power cable into the bikes charging port.
4. Connect the charger to an outlet.

During the charging process, the LED indicator on the charger lights up red to indicate that the battery is charging. When the color of the LED indicator switches to green, this indicates that the battery is fully charged.

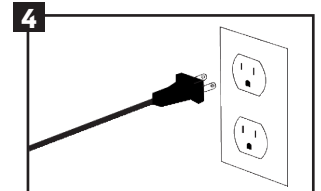
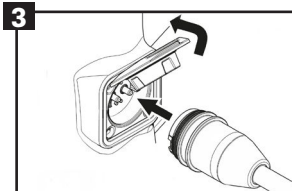
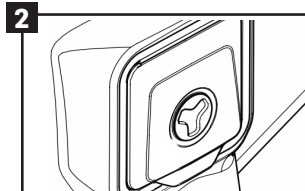
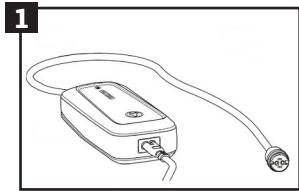

Control Element Details

NOTE: FAZUA offers multiple controller options. The Shuttle SL is equipped with the "Ring Control" and the "LED Hub". This manual specifically addresses the function of these elements. Additional information regarding the other remote options offered by FAZUA can be found on their website.

Ring Control

The Ring Control is a multi-function switch located just inside of the left grip on the handlebars.

This switch is used to turn the bike on and off.

- The switch is used to select between the different assist modes.
- Holding the switch up can activate Boost Mode.
- Holding the switch to the right accesses Walk Assist.
- The switch can also control lights if connected to the system.

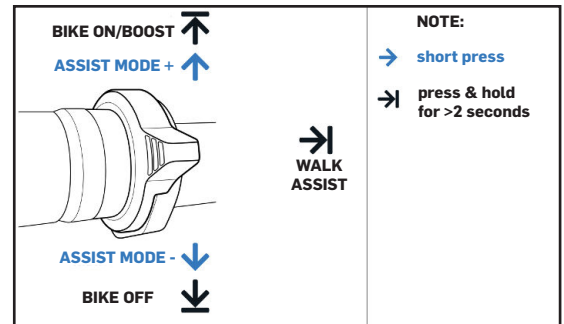

LED Hub

The LED Hub is located in the center of the top tube and provides system information to the rider.

The five LEDs indicate:

- Battery level
- Assist mode
- Bluetooth connectivity

If only the top LED is illuminated or flashing it indicates system information. ***See page 14 for system information and troubleshooting.**

The LED Hub houses a USB port for connecting to a PC or to plug in other accessories.

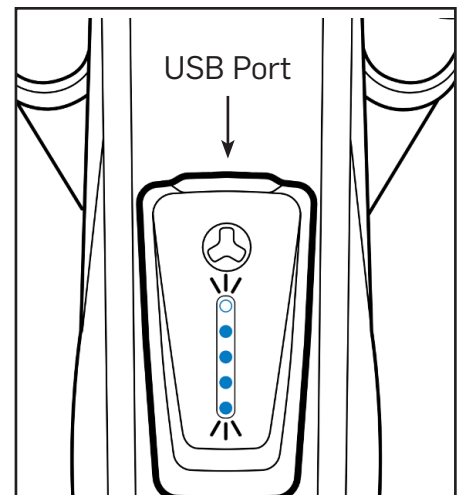



Powering the System ON and OFF

1. Locate the ring control on the left side of the handlebars.
2. Power the system on by pressing the controller up for at least 2 seconds. The five LEDs on the LED Hub will illuminate.
3. Once the power-up sequence is complete, the lights will illuminate to indicate the battery charge level.
(1 LED = 0-20%, 2 LEDs = 20-40%, 3 LEDs = 40-60%, 4 LEDs = 60-80%, 5 LEDs = 80-100%)
4. To turn off the system, press and hold the ring controller down for 1 second.

NOTE: The system will automatically turn itself off after extended non-activity. If no lights come on when you hold the controller up the battery may be asleep. This may require moving the bike to create enough motion to wake the battery up.

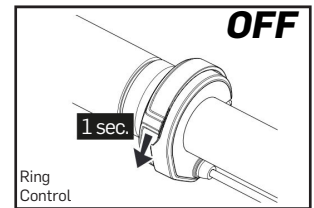
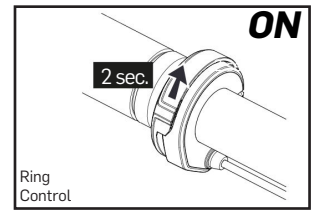

Support Modes

The Shuttle SL has 4 support mode as well as Boost and Walk Assist modes. The Ring Control is used to toggle between assist modes. The 5 lights found in the LED Hub change color to indicate the support level. No support is indicated with white lights. Breeze is the least amount of support and indicated with green lights. River is a moderate amount of support and indicated with blue lights. Rocket is the most support and indicated with pink lights.

NOTE: The color of the LEDs indicates the current assistance level. The number of LEDs illuminated shows the battery charge level.

Modes: There are four support levels (each with a distinct color) listed below from least to most support: No support (White), Breeze (Green), River (Blue), Rocket (Pink)

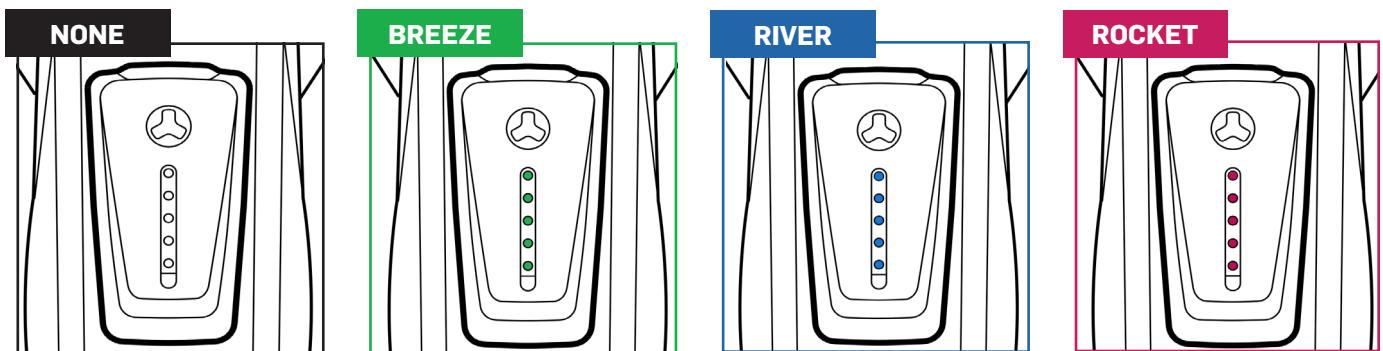

Changing Levels of Support

- Increase support by briefly pushing up on the switch. This will increase the support by one level and the LED Bar lights will change color to indicate the support mode.
- To decrease support briefly push down on the switch. The LED Bar lights will change color to indicate the support mode.

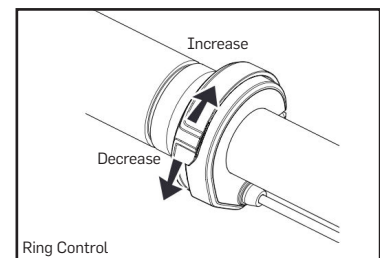



Boost Mode

Boost mode is an additional function the drive system has outside of the support levels. The Boost function allows you to ride with a (higher) maximum power of 450 watts for a short time to give you an extra push. The duration of Boost mode depends on when you activate it.

- Press and hold the switch up for at least one second to activate the boost function.
- The lights on the LED Hub will flash in sequence to show Boost Mode is activated.
- If you activate the Boost function from a standstill, you receive the power for 4 seconds.
- If you activate Boost while riding you will receive the added power for 12 seconds.
- Boost will be deactivated automatically after 4 or 12 seconds or if you stop pedaling.

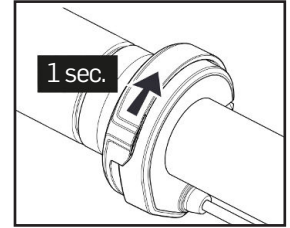

*Boost cannot be activated if you have not selected an assist mode (LEDs are white) or if your speed is above 20mph or 25 km/h.

Walk Assist Mode

The Shuttle SL features a Walk Assist Mode for when you may need to walk your bike. This function helps propel the bike forward to reduce your effort to push the bike.

1. Set the assistance level to "none." (LEDs will be white)
2. Press and hold the control switch towards the center of the handlebar to use walk assist. After 2 seconds, walk assist is activated and sets the bike in motion as long as you keep the control switch pressed.
3. Guide the bike with both hands and control the speed of the bike with your walking pace.
4. To end using walk assist release the control switch.

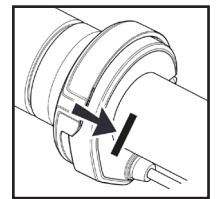

Using the LED Hub USB Port

- The LED Hub features a USB-C port. This port can be used to connect accessories to the Shuttle SL like a phone, GPS device, or lights for charging.
- This port is also used to connect your bike to a computer for use with the FAZUA Toolbox software for firmware updates and diagnostic functions.
- Gently lift up on the front of the hub to access the USB-C port.

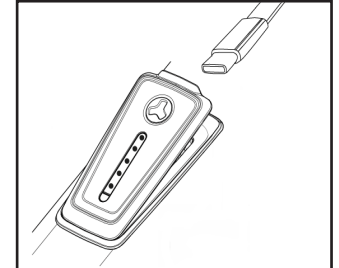
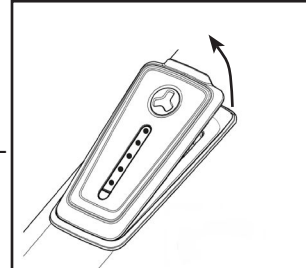

Speed Sensor

NOTE: The speed sensor magnet placement is critical to proper system function. The Shuttle SL features a magnet that is integrated into the disc brake rotor.

1. Make sure the magnet is in the proper position and distance from the sensor. Note the marking on the speed sensor. There is an embossed line indicating where the magnet should pass in front of the sensor.
2. In order for the speed sensor to function properly, the distance between the magnet and speed sensor must be between 1mm and 8mm.

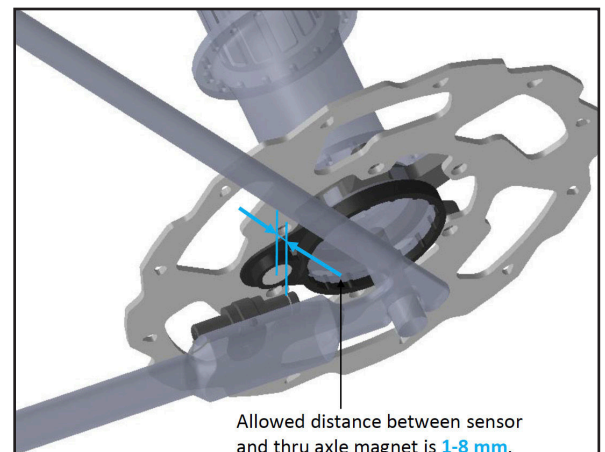



Support Characteristics

NOTE: The differences in support modes are measured by the varying values of 3 parameters.

Max Power: This parameter determines the maximum torque and power output. This parameter is defined by setting the maximum power output by the motor. This value can vary between 60-300 [W]. This is illustrated by the height of the dotted line along the y-axis of *Chart 1* and *Chart 2* below.

Support Relation: This parameter determines the relationship between rider power and motor support. This parameter is defined by setting at what rider power input the maximum motor power output is reached. This value can vary between 90-420 [W]. This relationship is illustrated by the slope of the solid "Support Relation" line in *Chart 1* below.

Ramp Up: This parameter determines the responsiveness of the motor and the strength of the acceleration. This parameter is defined by a percentage indicating how quickly the maximum motor power output is reached. This value can vary between 0-100 [%]. This is illustrated by the progressiveness of the curved solid "Ramp Up" line in *Chart 2* below.

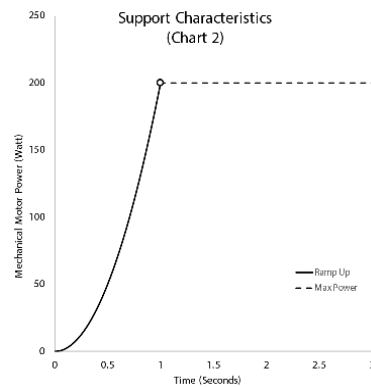
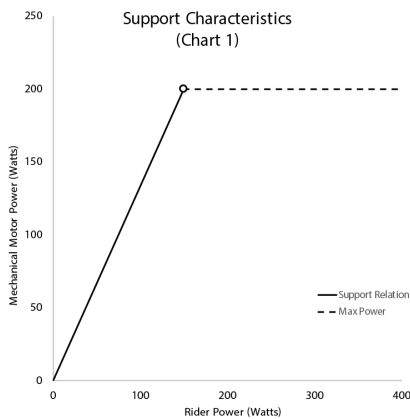

* These charts are for illustrative purposes only and do not necessarily represent actual support characteristics of Shuttle SL.

Factory Support Settings

NOTE: This is an example of the support curve for each of the three support modes. End-user customization is available and outlined in a later section of this manual.

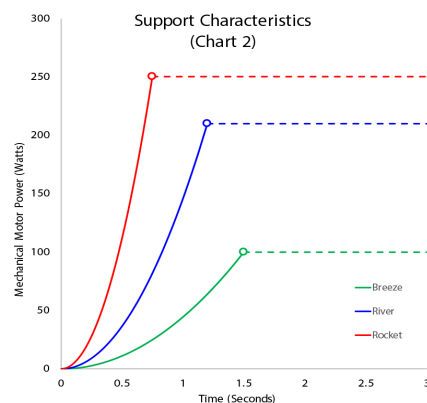
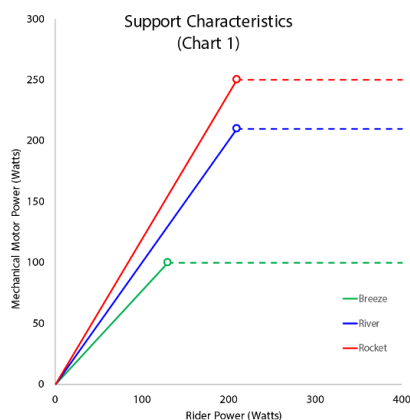



Download Mobile App

FAZUA App

The FAZUA App is the main control center for your FAZUA Energy Bike. Change your support mode settings in the customizer, download new support profiles from the store for free, and change between profiles for your Shuttle SL directly from your smart phone. This app can also be used as a dashboard if you wish to use your smartphone as a display.



Scan for the
FAZUA App

How to Install the FAZUA App

1. Ensure your drive unit and remote have the current firmware installed.

**See Fazua Software section on the following pages for information on firmware updates.*

2. Turn on Bluetooth in the phone settings.
3. Turn on the Ride 60 drive system fitted to your e-bike.
4. In the FAZUA app, either tap on bicycle icon in the upper left corner and the app will begin searching for your bike. A connection to your bike only needs to be established once using the FAZUA app.
5. The six-digit bonding key is required to connect your bike with a smart phone. This key can be found attached to the LED Hub on your Shuttle SL.
6. Once you have paired your phone to your bike you will not need to re-enter the bonding key.

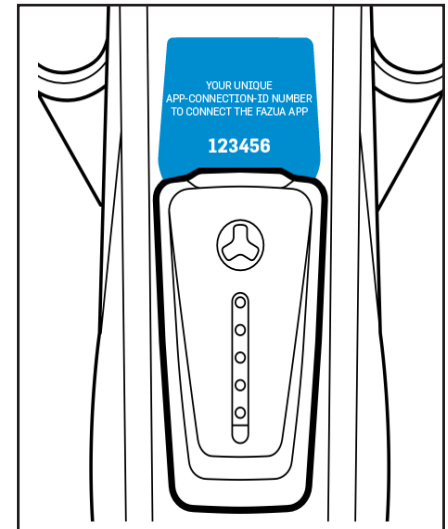



Download Software

NOTE: All software downloads can be accessed via the FAZUA website: <https://FAZUA.com/>

Download Desktop Software (FAZUA Toolbox)

1. Go to the website listed above and click on the "Desktop Software" link.
2. On the next page, select the operating system of your device click on the plus to view the system requirements and the "Download" link.
3. If all device requirements are met, click on the "Download" link.
4. Fill out the form that appears with your email address and first and last name. FAZUA requires this information, so they can contact end users when updates are made available.
5. Go to the file location of the downloaded ".exe" file, and open the file. This will open the FAZUA Toolbox, where all adjustments and updates can be made.

Connect to the FAZUA Toolbox

*NOTE: Before connecting to the FAZUA Toolbox, download the desktop software. A detailed video outlining the procedure for connecting the drive unit to the FAZUA Toolbox software can be found on the FAZUA website: <https://FAZUA.com> *If you are connecting to a Mac you will need to use a USB to USB-C adapter for the toolbox software to properly recognize your computer.*

1. Turn on the system by pushing up on the ring control for at least 2 seconds.
2. Lift the front cover of the LED Hub to access the USB C port.
3. Connect the bike to the computer using a USB cable.
4. Open the FAZUA Toolbox software and confirm that the drive unit has successfully connected by checking the lower left corner of the FAZUA Toolbox. Once successfully connected, all information and settings currently saved to the drive unit will be displayed under the various tabs in the left navigation panel.

FAZUA Toolbox Navigation Panel

NOTE: The left panel of the FAZUA Toolbox provides categorized information relating to the connected drive unit.

Product Information: System and component serial numbers and software versions.

Bike Usage: System odometer, temperature, max speed, power output, & battery cycles.

Diagnosis: Runs system diagnostics and outputs any system faults detected.

Live Data: Displays current system status.

Configuration: Displays OEM system configurations.

Customizer: Allows end user customization of each support level.

Software Update: Upload software updates to the system.





Customize Assistance Profiles

NOTE: A detailed video outlining the procedure for customizing the assistance profiles can be found on the FAZUA website: <https://FAZUA.com/>

1. Open the FAZUA Toolbox software and connect the drive unit. (Procedure provided above)
2. In the FAZUA Toolbox software, on the left panel, click on the "Customizer" menu.
3. From the "Customizer" menu, there are two methods for customization: EASY & ADVANCED.

Customization: EASY

NOTE: Under the "EASY" tab in the "Customizer" menu, each support parameter has three preset options that offer a range of options balancing energy consumption and support power.

Max Power: *Eco, Moderate, Performance*

The maximum motor power output is lower in the Eco setting, which saves battery and extends range. In the Performance setting, the maximum motor power output is higher, which increases battery consumption and reduces range. The Moderate setting is a balance between power output and energy consumption.

Support Relation: *Low, Moderate, High*

In the Low setting, the motor provides maximum support even with low rider input power. In the High setting, a lot of power must be applied by the rider for the motor to reach its maximum power output. The Moderate setting falls between the two extremes to balance required rider input and battery consumption.

Ramp Up: *Smooth, Moderate, Reactive*

In the Smooth setting, the motor accelerates slightly slower and more gently, whereas in the Reactive setting, the motor reacts much faster and accelerates stronger. In the Moderate setting, the acceleration rate is balanced with the battery consumption.

Customization: ADVANCED

NOTE: Under the "ADVANCED" tab in the "Customizer" menu, there are variable sliders that allow full user customization of the three support parameters for each of the three support levels. It is recommended that the users choose the EASY presets that most closely matches their needs, and then use the ADVANCED settings to fine tune the performance.

	BREEZE	RIVER	ROCKET
MAX POWER	60 [W] - 300 [W]	60 [W] - 300 [W]	60 [W] - 300 [W]
Level of maximum motor power output			
SUPPORT RELATION	90 [W] - 420 [W]	90 [W] - 420 [W]	90 [W] - 420 [W]
Reach of maximum power at defined rider power input			
RAMP-UP	0% - 100%	0% - 100%	0% - 100%
Activation of the motor and strength of the acceleration			





Setting Custom Assistance Profiles

To transfer the custom settings to the drive unit, click the "Set Values" button at the top of the screen.



Saving Custom Assistance Profiles

Once a custom configuration is created, click on "New", give the profile a name and click on "Save". All the profiles you have saved can be called up in the drop-down menu, even if the drive unit is not connected to the computer. The various profiles are saved to the FAZUA Toolbox software and will be available in the drop-down menu every time the program is opened.

Exporting Custom Assistance Profiles

NOTE: Saved profiles are saved to the FAZUA Toolbox and are always available when the desktop software is opened. The main reason to export a profile, would be to send a custom profile to another user. This allows profiles to be shared and uploaded to another user's device.

Once a custom configuration has been saved to the FAZUA Toolbox, it is available to be exported. To export a profile, click on "Export". In the menu that appears, select which profiles to export and click "Export". All profiles selected will be saved collectively as a set within a single .XML file. In the next menu, give the profile set a name and click "Save". The saved file contains all profiles that were selected and enables them to be imported individually or as a group.

Importing Custom Assistance Profiles

To import a profile, click on "Import". In the menu that appears, navigate to the location that the file is saved. Select the file and click on "Open". The next menu will have all profiles saved in that file appear with check marks next to each. Select which profiles to import and click on "Import". All selected profiles to import will now appear in the drop-down menu in the FAZUA Toolbox.

Update System Software

NOTE: A detailed video outlining the procedure for updating the system software can be found on the FAZUA website: <https://FAZUA.com/>

1. Open the FAZUA Toolbox software and connect the drive unit. (Procedure provided above)
2. Go to <https://FAZUA.com/> and click on the "Drive System Software" link.
3. On the next page, under the "Latest Version" header, click the "Download" link. Note where this file is saved.
4. In the FAZUA Toolbox software, at the bottom of the left panel, click on the "Software Update" menu.
5. In the "Software Update" menu, click on "Select Software" in the upper right hand corner. This will open a document search menu.
6. In this menu, search for and open the recently downloaded "Drive System Software" file.
7. Click "Update"
8. Do not move the bike during the update process. Make sure it is stable during the process.
9. Wait for the update to install and the motor calibration to complete.
10. Disconnect the USB cable from the LED Hub.
11. Once you install the drive unit with the new motor software into the e-bike, the remote will receive an update. The LEDs will flash during this process.





Troubleshooting Table

NOTE: If the system is not functioning as desired, first check whether the fault can be rectified using the following overview table. If the error is not listed below or the recommendations do not correct the issue, contact a FAZUA service partner or visit the FAZUA support platform: <https://FAZUA.com/>

ISSUE	POTENTIAL CAUSE/SOLUTION
The drive system feels weaker than usual.	The drive system is brand new. Wait until the drive system is "run in". The drive system needs a few miles to develop its full power.
	It is very hot and the heat management of the battery and/or drive unit limits the performance.
	It is very cold and the battery (=lithium-ion battery) does not deliver the usual performance.
The upper LED on the LED Hub flashes red.	There is a connection error between the drive unit and battery. Loose connectors or jammed cables may be preventing the connection. *Take your bike to an authorized Pivot dealer for service.
The upper LED on the LED Hub flashes yellow.	There may be a bad connection between the speed sensor and bottom bracket. Check that the speed sensor and magnet are intact and correctly located. *If they intact and still showing the fault, take your bike to an authorized Pivot dealer for service.
The upper LED on the LED Hub is white.	There is a connection issue between the battery and drive unit. *Take your bike to an authorized Pivot dealer for service.
The upper LED on the LED Hub flashes blue.	This is normal and indicates that there was enough movement of the battery to wake it up to be ready to power the system on.
The white LEDs of the LED Hub Flash.	Software update. After a new firmware update, the control element is updated automatically. In this case, please wait and do not switch off the control element until the LEDs stop flashing.
The control element/display cannot be switched on.	The battery may be asleep after a long rest period. To wake the battery up it may require enough movement to activate the battery. Try moving the bike until you see the top light on the LED hub light up, then it should turn on as normal.
	The battery may be exhausted. Try charging the battery.
	There is a connection issue between the battery and drive unit. *Take your bike to an authorized Pivot dealer for service.
The pedal support suddenly fails while riding.	BMS protection function. Shut down the drive system by pressing and holding the control switch down for 8 seconds. When the drive system is ready to be switched on again, the status indicator LED flashes green. Now you can restart your drive system as usual.
My Mac computer will not connect to the Toolbox Software.	Connecting directly to the Shuttle SL with a USB-C cable may not connect to the Toolbox Software. Use a USB-C to USB adapter for proper connectivity to the software.





FAZUA Ride 60 System Schematic

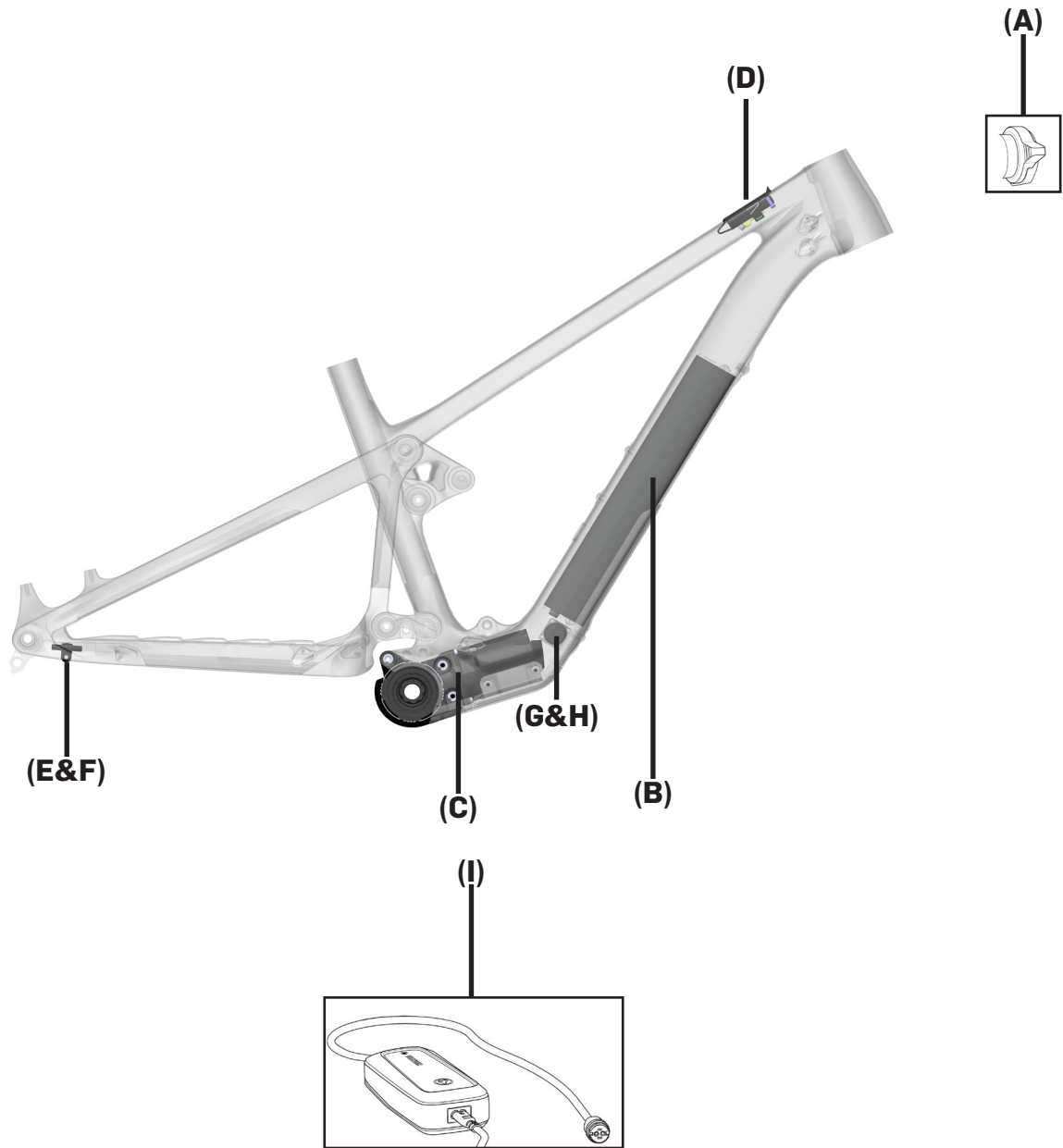

LETTER	PART DESCRIPTION	PART NAME
A	Ring Control (Drive Unit Switch)	31A101000A
B	Battery (Energy 430 fix)	20A101100A
C	Drive Unit	10A101100A
D	LED Hub	30A102200A
E	Speed Sensor (Magnet included on rotor)	61A101100A
F	Speed Sensor Holder	61A103000A
G	Battery Charging Port	61A102000A
H	Charging Port Cover	61A105000A
I	Battery Charger - US/CA	21A101000A + 21A102200A
	Battery Charger - EU	21A101000A + 21A102000A





Small Parts Schematic

SHUTTLE SUPERLIGHT				
Hardware				
NUMBER	PART NUMBER	DESCRIPTION	TORQUE	*
3	FP-CVR-SSLV1-SKD-V1-R1	Shuttle SL V1 Skid Plate		
4	FP-UDH-TA-12MM-BLK-V1-R1	Universal Rear Derailleur Hanger		
5	-	Universal Rear Derailleur Hanger Bolt	25 Nm (18 lb-ft)	
6	-	Universal Rear Derailleur Hanger Washer		
7	FP-LNK-UL-61MM-V1-R1	61mm Upper Link		
8	FP-LNK-LL-45MM-V2-R1	45mm Out-to-Out Lower Link		
9	FP-BRG-6902-LLUMAXECN	28mm 6902 Extended Max-E Bearing		R
10	FP-BRG-6902-LLUMAX	28mm 6902 Standard Max Bearing		R
11	FP-BRG-6900-LLUMAXE	22mm 6900 Ext'd Max-E Bearing		R
12	FP-BLT-M8*45.7-BLK-V2	M8 Front Shock Bolt for 30.1mm Shock Spacing	13 Nm (10 lb-ft)	G / L
13	FP-BLT-M14*20-BLK-V2-R2	M14x20 Link Bolt	35 Nm (27 lb-ft)	L
14	FP-BLT-M10*16.5-BLK-V1	M10 Trunnion Mount Bolt	13 Nm (10 lb-ft)	L
15	FP-BLT-M14*20-BLK-V3-R2	M14x20 Flip Chip Bolt	35 Nm (27 lb-ft)	L
16	FP-NUT-FLIPCHIP-4.6MM-V1	4.6mm Flip Chip		G
17	FP-WSH-SPC-151*250*3W	M14x3mm Flip Chip Spacer		G
18	FP-CLM-MECH-FRM-V1	Internal Routing Cable Clamp		
19	FP-CVR-MECH-FRM-V2	Internal Routing Hole Cover		
20	FP-CLM-DUAL-FRM-V1	Internal Routing Dual Clamp		
21	FP-CLM-MECH-FRM-V2	Internal Routing Cable Clamp (Mirrored)		
22	FP-SCW-FLT-M3*10	M3x10 Cable Clamp Screw (Included w/ Clamp)		
23	FP-GDE-CHN-V1-R1	Chain Guide Mounting Plate		
24	-	Upper Chain Guide		
25	-	M5x12 Flat Head CG Mounting Screw	5 Nm (4 lb-ft)	L
26	FP-MNT-SSLV1-BATT-V1-R1	Battery Bracket Mounting Plate		
27	FP-SCW-BTN-M6*12-V1-R1	M6x12 Button Head Battery Bracket Mounting Screw	8 Nm (5.9 lb-ft)	L
28	FP-PLT-CBL-ROUTING-V1-R1	Cable Routing Plate		
29	FP-CVR-MTR-EBIKE-V1-R1	Speed Sensor Wiring Motor Cover		
30	FP-SCW-SCK-M4*10-V1-R1	M4x10 Speed Sensor Plate Mount Screw		
31	FP-SCW-BTN-M4*10-V1-R1	M4x10 Button Head Speed Sensor/Cable Routing Mounting Screw	2 Nm (1.4 lb-ft)	L
32	FP-WSH-4I*100*1W	M4 Washer		
33	FP-SCW-BTN-M5*12*T25	M5x12 Button Head Skid Plate Mounting Bolts	4 Nm (2.95 lb-ft)	L
34	FP-WSH-M5*10*1-V1-R1	M5 Washer		
35	FP-GKT-SSLV1-SKD-V1-R1	Skid Plate Gasket		
36	FP-PLG-RNG-EXT-V1-R1	Range Extender Rubber Plug		
37	FP-MNT-CHRG-PORT-V1-R1	Charging Port Mounting Plate		
38	FP-BLT-FLT-M2.5*12-V1-R1	M2.5x12 Flat Head Charging Port Mounting Bolts		
39	FP-BLT-BTN-M5*6-V1-R1	M5x6 Water Bottle Bolt		
40	FP-PRO-SSLV1-SP-V1-R1	SHTL SL V1 Skid Plate Protector		
41	FP-PRO-SSLV1-DT-V1-R1	SHTL SL V1 Downtube Protector		
42	FP-PRO-SSLV1-MP-V1-R1	SHTL SL Motor Protector		
43	FP-PRO-SSLV1-CS-V1-R1	SHTL SL V1 Chainstay Protector		
44	FP-PRO-SSLV1-SS-V1-R1	SHTL SL V1 Seatstay Protector		
45	FP-PRO-SSLV1-UR-V1-R1	SHTL SL V1 Upright Protector		
46	FP-PRO-45MM-LL-V2-R2	45mm Lower Link Protector		
47	FRAME SIZE STICKER - XS/SM/MD/LG/XL	Frame Size Sticker		

Axles				
NUMBER	PART NUMBER	DESCRIPTION	TORQUE	*
101	157MM THROUGH AXLE V5	157mm UDH Rear Axle	15 Nm (11 lb-ft)	G
102	-	12mm Axle Washer (Included w/ Axle)		

Bike Care		
*	PRODUCT TYPE	RECOMMENDED PRODUCT
G	Grease	Motorex Bike Grease 2000
L	Thread Locker**	Loctite Thread Locker #243 (or equivalent)
G/L	Grease (Bolt Shaft) / Thread Locker (Bolt Threads)	See Above
A	Anti-Seize	Motorex Copper Paste
R	Retaining Compound	Loctite Retaining Compound #620 (or equivalent)

**Threadlocker should always be applied to the corresponding female threads for the bolt specified

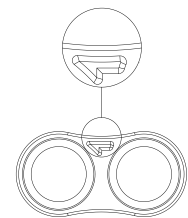
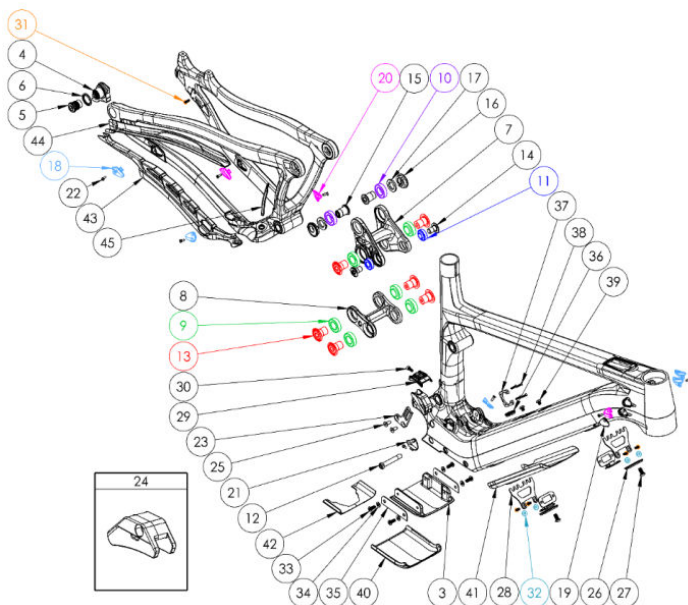





ATTENTION: Lower links are marked with an arrow on the non-drive side. The link must be oriented where the arrow points to the front triangle.



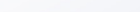
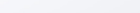
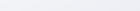

Wiring Diagram

-  Ring Control Wire
-  LED Hub Wire
-  Speed Sensor Wire
-  Charging Port Wire
-  Shift Housing
-  Brake Line
-  Dropper Post Housing

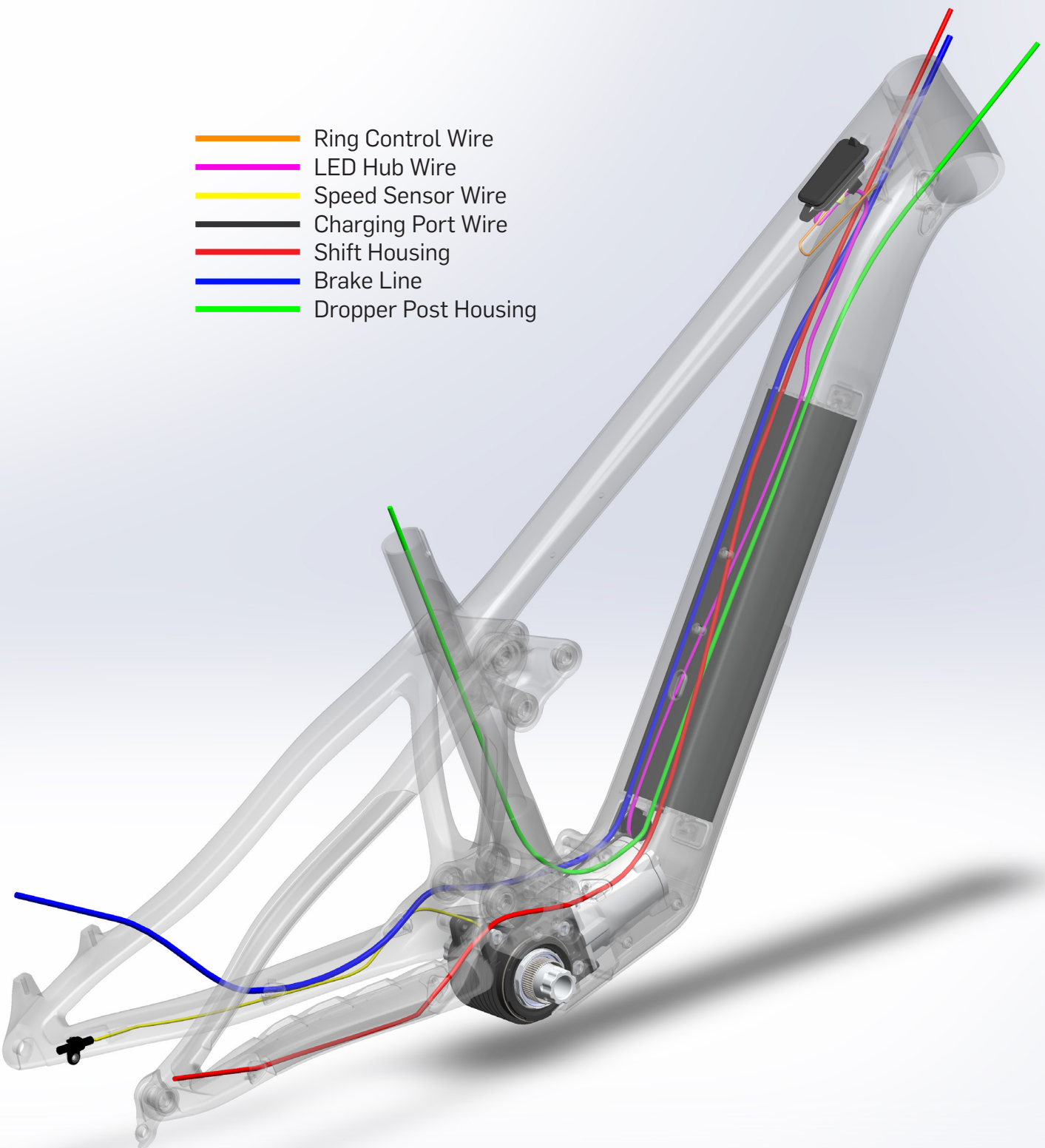



Compatible Devices

*NOTE: A third party device is normally compatible if it includes a BLE interface (Bluetooth 4.0 or higher).
The list of connectable devices includes the following:*

Garmin: Edge 530, Edge 830, Edge 1030, Fenix 5 Plus Series, Fenix 6, Forerunner 945, MARQ

Wahoo: ELEMNT ROAM, ELEMNT BOLT

Sigma: iD.TRI, iD.FREE

Lezyne: Mega XL, Super Pro

Garmin Pairing

NOTE: A user's Garmin can be paired to the Shuttle SL to display cadence or power.

1. On the Garmin, select the three horizontal bars at the lower right of the screen to access the main menu.
2. Select "Sensors".
3. Select either "Cadence" or "Power". The FAZUA system can provide one or the other, but not both simultaneously.
4. Select "Add Sensor".
5. The Garmin will begin searching for the Shuttle SL. Turn on the Shuttle SL by pressing the center FAZUA button on the controller. The lights will flash blue three times.
6. The Garmin will find power or cadence/speed depending on what was selected. Select "Add".
7. The customer can now choose to add a new data screen to support the newly added sensor.





Bicycle Safety

- Read and follow the manufacturer's instructions for e-bike use.
- Research and observe any applicable national, state, or local laws and regulations regarding e-bikes and their use.

Improper Use Hazards

- Under no circumstances should the end user modify or alter individual components of the drive system autonomously.
- Never replace and components of the drive system without authorization.
- Never open the drive system components without authorization. The drive system components do not require any maintenance. Only allow repairs to drive system to be carried out by an authorized specialist.
- Only allow components of the drive system to be replaced by an authorized specialist with permissible original spare parts.
- Remove the drive unit from the e-bike while the e-bike is being transported or stored and during all work on the e-bike to prevent the drive system from being started accidentally.
- Only use original FAZUA Ride 60 batteries approved by the e-bike manufacturer.
- Never use a damaged battery and never try to charge a damaged battery.
- Never open the battery. If you try to open the battery, there is an increased risk of explosion.
- Keep the battery away from heat (e.g. strong sunlight), open fire, or water or other liquids.
- Only use the battery in e-bikes equipped with an original FAZUA Ride 60 drive system. Never use the battery for other purposes or in other drive systems.
- Follow all charging instruction and do not charge the battery outside of the temperature range specified in the instructions. Charging improperly or at temperatures outside of the specified range may damage the battery and increase the risk of fire.
- Do not modify or attempt to repair the charger or the battery.
- To charge the battery, use only original and compatible Ride 60 chargers from FAZUA.
- Take care not to handle metal objects such as coins, paper clips, screws, etc. in the immediate vicinity of the battery and to store the battery separately from metal objects. Metal objects can close a circuit between the terminal of the battery (i.e. "short-circuit" the battery) and cause a fire.
- Do not short-circuit the battery.
- Battery and charger may heat up during charging or operation. It is therefore essential to keep the battery and charger away from flammable materials. Pay particular attention during the charging process and always move the battery and charger to a dry and fireproof place before charging.
- Do not leave the battery and charger unattended during charging.
- This appliance is not intended for use by persons (including children) with reduced physical, sensory, or mental capabilities, or lack of experience and knowledge, unless they have been given supervision or instruction concerning use of the appliance by a person responsible for their safety.
- Children shall not play with the appliance.
- Only for rechargeable Li-ion battery.
- Don't attempt to disassemble the charger by yourself.
- Don't use the charger in high temperature, moist, inflammable or explosive outdoor environments.
- Disconnect the power supply before making or breaking the connections to the battery.





Health Hazards

- Protect the battery from mechanical influences and any other load.
- If you notice or suspect that gas is leaking from the battery, immediately ensure a supply of fresh air and seek medical attention as soon as possible.
- Keep the battery and charger away from pacemakers or persons wearing a pacemaker and draw the attention of persons with pacemakers to the danger.
- Only connect the charger to an easily accessible and properly installed power outlet.
- Make sure that the mains voltage at the mains connection corresponds to the information on the charger.
- Only use the charger in dry indoor areas.
- Keep the charger away from any liquid or moisture.
- Do not pull on the mains or charging cable to pull the respective cable out of a socket or outlet, but always hold the corresponding plug.
- Do not handle the plugs of the power cord and charging cable with wet or damp hands.
- Take care not to bend the power cord and charging cable or lay them over sharp edges.
- Do not open the charger without authorization. The charger may only be opened by an authorized specialist and repaired using original spare parts.
- Before each use of the charger, check all individual parts (mains adapter, mains cable, charging cable, and all plugs) for damage. If the charger's power cord is damaged, it must be replaced by the manufacturer, their customer service, or a similarly qualified person, to avoid hazards.
- Never use a damaged charger. Otherwise there is a high risk of electric shock.
- Keep the charger in a clean condition. There is an increased risk of electric shock if the charger is dirty or contaminated.
- Do not touch any liquid leaking from the battery
- Should you ever come into contact with battery acid, immediately rinse the affected body part thoroughly under plenty of running water.
- Consult a doctor immediately after rinsing, especially in case of eye contact and/or if mucous membranes (e.g. nasal mucosa) are affected.
- The radiator of the drive unit can become very hot during operation.
- Allow the drive unit to cool down completely before touching the drive unit.

Potential Damage Hazards

- Have individual components of the drive system and the e-bike replaced exclusively by identical components or other components expressly approved by the e-bike manufacturer. This will protect the other components of your e-bike from possible damage.
- Never use your e-bike without a drive unit.
- When charging the battery, make sure the charging cables are not trip hazards in order to prevent components from being damaged by a fall.





FAZUA Ride 60 Drive System

- Additional information regarding operation and functionality of the FAZUA Ride 60 Drive System can be found at: <https://FAZUA.com/>
- To download the FAZUA software and mobile apps to fully utilize the connectivity and customizability of the FAZUA Ride 60 Drive System visit: <https://FAZUA.com/>

Pivot Shuttle SL

- For FAQs and additional technical documents regarding the maintenance of the Pivot Shuttle SL can be found at: <https://global.pivotcycles.com/products/shuttle-sl>

Conformity

FAZUA confirm the conformity according to 47 CFR Section 15.105 - Information to the user. This equipment has been tested and found to comply with the limits for a Class B digital device, pursuant to part 15 of the FCC Rules. These limits are designed to provide reasonable protection against harmful interference in a residential installation. This equipment generates, uses and can radiate radio frequency energy and, if not installed and used in accordance with the instructions, may cause harmful interference to radio communications. However, there is no guarantee that interference will not occur in a particular installation. If this equipment does cause harmful interference to radio or television reception, which can be determined by turning the equipment off and on, the user is encouraged to try to correct the interference by one or more of the following measures:

- Reorient or relocate the receiving antenna
- Increase the separation between the equipment and receiver
- Connect the equipment into an outlet on a circuit different from that to which the receiver is connected.
- Consult the dealer or an experienced radio/television technician for help.

Sources

- Portions of this document have been sourced from information provided by FAZUA. Additional end-user documentation can be found at: <https://FAZUA.com/>





Notes:

.....

.....

.....

.....

.....

.....

.....

.....

.....

.....

.....

.....

.....

.....

.....

.....

.....

.....

.....

.....

.....

.....

.....

.....



Notes:

.....

.....

.....

.....

.....

.....

.....

.....

.....

.....

.....

.....

.....

.....

.....

.....

.....

.....

.....

.....

.....

.....

.....





6720 South Clementine Court
Tempe, AZ 85283

T +1 480 467 2920
info@pivotcycles.com
www.pivotcycles.com
