



SHUTTLE AM

 **BOSCH** *ePowered*

PIVOT SHUTTLE AM

Original Operational Instructions

This manual is intended to provide you with the information needed to get you on the trail, walk you through the steps necessary to set up all the components, and become familiar with the Bosch E-bike System. This document contains some helpful diagrams and reference material to make sure you have everything necessary to maintain your Shuttle AM and enjoy it to the fullest.



TABLE OF CONTENTS		PAGE
1. Quick Start Guide		1
- Basic Suspension/Tire Set-up		1
- Adjusting Saddle Height		1
- Charging the Battery		1
- Powering the System ON and OFF		1
- Mini Remote and System Controller Function		2
- Adjusting Levels of Assistance		2
2. Bike Set-up		3
- Setting Proper Sag		3
- Setting Compression Damping on the Fox Float X		3
- Using the Climb Switch on the Fox Float X		3
- Setting Rebound Damping on the Fox Float X		4
- Setting Air Pressure on Fox 36 and 38 Forks		4
- Setting Compression Damping on Fox 36 and 38 Forks		5
- Setting Rebound Damping on Fox 36 and 38 Forks		5
- Recommended Tire Pressure		5
3. System Operation		6
- Battery Charge Indicator		6
- Establishing a Smart Phone Connection		6
- Connecting the Mini Remote to the System Controller		6
- Rim Magnet Speed Sensor		6
4. System Information		7
- Riding Mode Customization		7
- Display Options		7
- eBike Lock		7
- Connect Module		7
- System Updates		7
- Error Messages		7
5. Schematics		8
- Bosch Drive System Schematic		8
- Small Parts Schematic		9
- Small Parts Table		10
- Wiring Diagrams		11
7. Additional Information		12
- Bicycle Safety		12
- Battery Safety		12
- Sources		13
- Notes		14

This "Quick Start Guide" provides the essential information to set up your bike.

Suspension/Tire Set-up

COMPONENT		QUICK START SETTING
Shock Air Pressure (by Body Weight) <i>! Always Check Sag see page 3 !</i>	Body Weight in [kg] to [bar]	$0.15 \times \text{Body Weight [kg]} + 2 \text{ [bar]}$
	Body Weight in [kg] to [psi]	$2.2 \times \text{Body Weight [kg]} + 30 \text{ [psi]}$
	Body Weight in [lbs] to [bar]	$0.07 \times \text{Body Weight [lbs]} + 2 \text{ [bar]}$
	Body Weight in [lbs] to [psi]	$\text{Body Weight [lbs]} + 30 \text{ [psi]}$
Shock Compression Damping		8 clicks in from OPEN*
Shock Rebound Damping		6 clicks in from OPEN
Fork Air Pressure		80 [psi] / 5.52 [bar]
Fork Compression Damping		HSC: 2 clicks in from OPEN* ; LSC: 5 clicks in from OPEN
Fork Rebound Damping		HSR: 3 clicks in from OPEN* ; LSR: 7 clicks in from OPEN
Front Tire Pressure		23 [psi] / 1.58 [bar]
Rear Tire Pressure		28 [psi] / 1.93 [bar]
* These Adjustments are not available on all builds.		

Adjusting Saddle Height

1. Use a 2mm hex wrench, loosen the drive side cable port cap securing the dropper post housing. (fig. 1)
2. Using a 4mm hex wrench, loosen the seat post clamp bolt and raise/lower the saddle to the preferred height. (fig. 2)
3. Using a 4mm hex wrench, tighten the seat post clamp bolt to 5 Nm.
4. Tighten the cable port cap screw with a 2mm hex wrench to secure the dropper post housing.

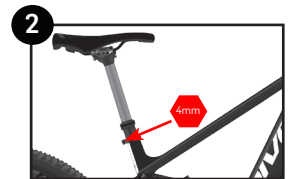
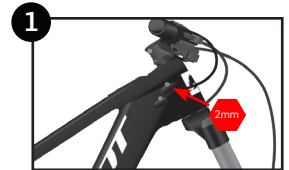

Charging the Battery

NOTE: The battery does not come fully charged and must be charged completely before the first use.

1. Locate the rubber charging port cover on the non-drive side of the frame. (fig.3)
2. Pull back the sealing cover to access the charging terminal.
3. Insert the charging cable into the charging terminal, ensuring the cable and terminal are properly aligned. (fig. 4)
4. The system controller will illuminate and display the charging status.
5. When done charging, remove the cable from the terminal and close the sealing cover.
6. The LED bars on the System Controller indicate the state of the battery's charge.

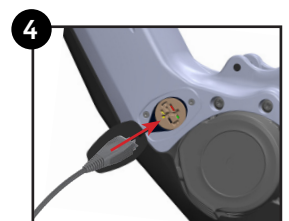
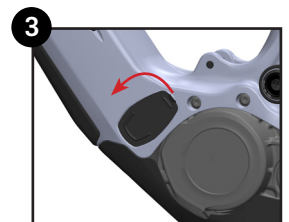

***The battery is fixed in the frame and should only be removed by an authorized dealer.**

Powering the System ON and OFF

1. The power button is located in the system controller on the top tube. (fig. 5)
2. Power the system on or off with a quick press and release on the power symbol near the top of the controller. The System Controller will power up and power down with an animation of the five LED bars.
3. If the bike has not moved for 10 minutes, the power will shut off automatically.



Mini Remote and System Controller Function

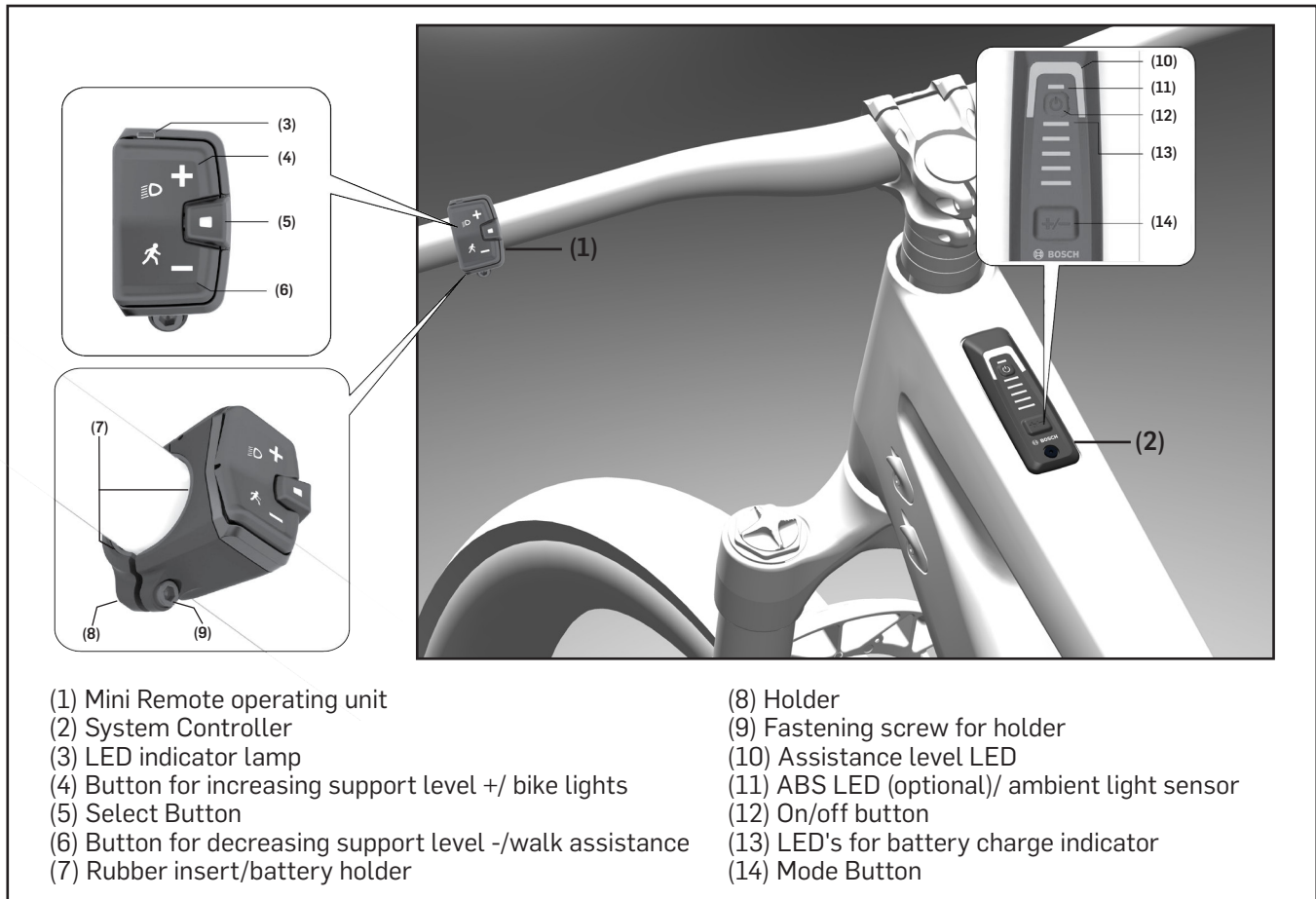

Adjusting the Level of Assistance

- The assist level can be selected with the Mini Remote **(1)** or with the System Controller **(2)**.
- Mini Remote: Briefly press (< 1 s) the + **(4)** button to increase assistance. Briefly press (< 1 s) the - **(6)** button to decrease assistance.
- System Controller: Briefly press (< 1 s) the mode button **(14)** to increase assistance.
- Press the mode button **(14)** for longer than 1 s to decrease the assistance.
- The assistance level can be changed at any time, even while cycling, and is displayed in color on the Assistance level LED **(10)**. See the table below for assist modes, LED color, and description.
- The Shuttle AM also features walk assist. To start walk assistance, press the **(6)** button for < 1 s and keep it pressed. The battery charge indicator **(13)** goes out and a white moving light in the direction of travel shows that it is ready. Releasing the **(6)** button pauses walk mode.

LED COLOR	ASSIST DESCRIPTION
LED OFF	Motor support is switched off. The bike can be pedaled as a normal bike
GREEN	Effective support with maximum efficiency, for maximum range
BLUE	Steady support, long range for touring
PURPLE	Optimal support whatever the terrain, improved dynamics and top performance
RED	Maximum support even at a high cadence, for sport cycling
FLASHING SEQUENCE	Walk assist. The battery charge indicator (13) LEDs turn off then flash in the direction of travel.

Setting Proper Sag

1. Always set sag with the *blue* climb switch lever to the open position. (fig. 1)
2. If your shock has additional compression and rebound adjustments ensure they are adjusted to be fully open, compression to the softest setting, and rebound to its fastest setting. Do this by rotating them fully counter-clockwise.
3. If it is not installed already, attach the sag indicator to the bottom of the shock body using the provided zip-tie and carefully cut the excess. (fig. 2)
4. Find a level surface and something to steady yourself while mounted on the bike so you can be on the pedals in a seated position. It may be easier to have a partner hold your bike steady from the front, by holding the handlebars while you are in your riding position.
5. While standing on the pedals, sit down hard into the saddle to cycle the suspension well into the stroke. This will ensure the bike comes to rest at the natural sag setting with the rider in the saddle.
6. While in the saddle and not moving, slide the O-ring up into position against the air can. (fig. 3)
7. Once the O-ring is set in place, slowly step off the bike so as not to move the O-ring.
8. Make adjustments to the sag by removing or adding air so that steps 4-7 result in the O-ring lining up with the *red* line on the sag indicator. (fig. 4) When adjusting air pressure in the shock, cycle the shock before re-checking sag, so the large Evol negative air chamber equalizes pressure with the main chamber each time air is added or removed. You can do this by pushing down on the saddle several times to compress the shock past the sag point.

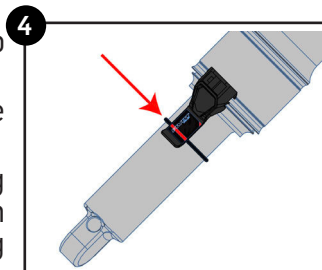
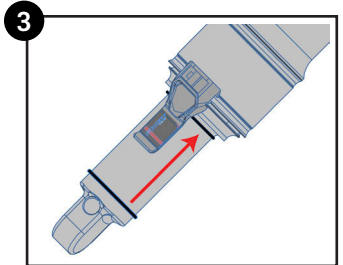
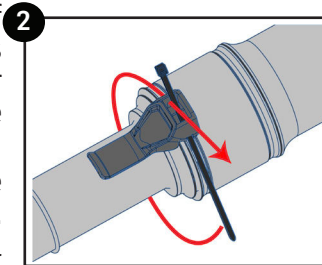
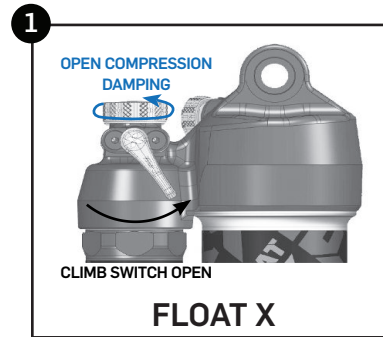

WARNING: Make sure the sag indicator does not contact the frame or linkage through the suspension cycle. Otherwise, the indicator may break while riding.

Setting Compression Damping on the Fox Float X

- Some Factory Series Float X features a *blue* low speed compression adjustment knob, which can be used to fine tune the open mode of the compression damping. This knob offers 10 additional fine tune adjustment settings to the open mode.
- Turning the knob clockwise will increase low speed compression damping. Turning the knob counter-clockwise will decrease low speed compression damping. You can experiment with all of these options to find the setting that provides the best compression support and plushest feel for your weight and riding style.
- For a rider close to 100lbs, we recommend having the compression fully open, by having the knob turned fully counter-clockwise. For riders 200lbs we like to start at 3 clicks in from full closed as a good baseline setting. If the rider's weight is less than 200lbs, open up compression damping 1 click counter-clockwise for every 10lbs. less. For every 10lbs over 200lbs we recommend increasing compression damping by 1 click clockwise.



Using the Climb Switch on the Fox Float X

Some Float X shocks feature a two position lever allows for on-the-fly adjustment between fully open and firm for climbing. As with other shocks, the firm setting is best suited for long fire road climbs and smooth XC courses.

Setting Rebound Damping on the Fox Float X

- Rebound is set from the most open (fully counter-clockwise) position.
- The rebound setting is determined by the air pressure in the shock.
- Refer to the table below for the suggested rebound setting. The number in the chart refers to how many clicks in (clockwise) from the open setting the rebound should be set. Fox sets rebound from the closed position, so that has been provided in the table in parentheses.

FLOAT X REBOUND KNOB

AIR PRESSURE		SUGGESTED REBOUND SETTING FLOAT X
[bar]	[psi]	
< 8.3	<120	1 (9)
8.3 - 9.7	120-140	2 (8)
9.7 - 11	140-160	3 (7)
11 - 12.4	160-180	4 (6)
12.4 - 13.8	180-200	5 (5)
13.8 - 15.2	200-220	6 (4)
15.2 - 16.5	220-240	7 (3)
16.5 - 17.9	240-260	8 (2)
17.9 - 19.3	260-280	9 (1)
19.3 - 20.7	280-300	CLOSED

Clicks from **OPEN** (Clicks from **CLOSED**)

Setting Air Pressure on the Fox 36 Forks

- Fox recommends setting sag between 15% and 20% of the total fork travel. The Shuttle AM comes with a 160mm fork, so the proper sag measurement is 24.0 - 32.0mm.
- The air pressure in the Fox 36 forks should not exceed 8.3 [bar] (120 [psi]).
- To achieve the proper sag, reference the chart below for an initial starting point.
- Just like with the shock sag the fork needs to be equalized when the pressure is changed. Press down on the fork a few times after making a pressure change to get an accurate measurement.

RIDER WEIGHT		FOX 36 AIR PRESSURE
[kg]	[lbs]	
55 - 59	120 - 130	58 [psi] / 4.0 [bar]
59 - 64	130 - 140	64 [psi] / 4.4 [bar]
64 - 68	140 - 150	68 [psi] / 4.7 [bar]
68 - 73	150 - 160	72 [psi] / 5.0 [bar]
73 - 77	160 - 170	76 [psi] / 5.2 [bar]
77 - 82	170 - 180	80 [psi] / 5.5 [bar]
82 - 86	180 - 190	84 [psi] / 5.8 [bar]
86 - 91	190 - 200	89 [psi] / 6.1 [bar]
91 - 95	200 - 210	93 [psi] / 6.4 [bar]
95 - 100	210 - 220	97 [psi] / 6.7 [bar]
100 - 105	220 - 230	102 [psi] / 7.0 [bar]
105 - 109	230 - 240	106 [psi] / 7.3 [bar]
109 - 114	240 - 250	110 [psi] / 7.6 [bar]

Setting Compression Damping on the Fox 36 Grip 2 Forks

- To set compression, start from the open (or fastest) position by turning the *black* (LSC) dial & *blue* (HSC) dial counterclockwise until they stop clicking.
- A good starting point for most riders is to turn the *black* (LSC) dial clockwise 5 clicks & turn the *blue* (HSC) dial clockwise 2 clicks.
- The recommended starting points may need to be adjusted based on rider weight. Lighter riders may prefer less compression damping (fewer clicks from open).



GRIP2 Compression Knob

Setting Compression Damping on the Fox 36 Grip Forks

- We always start with the lever in the full open position. Most riders will not need to make any changes from this position.
- If you do need more compression support, the lever will provide a low speed compression adjustment until the lever is turned halfway.
- Fully closed provides a nearly locked out feel for climbing.



GRIP Compression Knob

Setting Rebound Damping on the Fox 36 Forks

- Remove the protective cover over the rebound knobs on the lower fork leg.
- To set rebound, start from the open (or fastest) position by turning the *red* rebound dial(s) on the bottom of the right fork leg counterclockwise until it stops clicking. On the Fox 38 Grip 2 there are two dials. One for high speed and one for low speed.
- Refer to the chart below for the recommended settings when setting rebound. Fox clicks are in parentheses.

RIDER WEIGHT	FOX 36 SUGGESTED REBOUND
	LSR / HSR *HSR not available on all builds
120-130 [lbs]	3 / Open (12 / 10)
130-140 [lbs]	4 / Open (11 / 10)
140-150 [lbs]	5 / 1 (10 / 9)
150-160 [lbs]	6 / 2 (9 / 8)
160-170 [lbs]	7 / 3 (8 / 7)
170-180 [lbs]	8 / 4 (7 / 6)
180-190 [lbs]	8 / 4 (7 / 6)
190-200 [lbs]	9 / 5 (6 / 5)
200-210 [lbs]	9 / 5 (6 / 5)
210-220 [lbs]	10 / 6 (5 / 4)
220-230 [lbs]	11 / 7 (4 / 3)
230-240 [lbs]	11 / 7 (4 / 3)
240-250 [lbs]	12 / 8 (3 / 2)

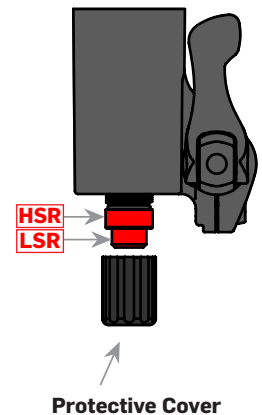

Clicks from OPEN (Clicks from CLOSED)

Recommended Tire Pressure

- Tire pressure is an important factor on having the bike ride properly. If the tire pressure is too high, the tire will not conform to ground, reducing traction. If the tire pressure is too low, the tire could pinch flat.
- It is important to have an accurate pressure gauge when setting tire pressure; preferably a digital gauge with a 0.03 [bar] (0.5 [psi]) accuracy.
- The recommended tire pressure will vary slightly based on rider weight, riding style, and terrain.
- Some riders may find it helpful to start a ride at a slightly higher pressure than recommended and let out a little air throughout the course of the ride until you find your ideal riding tire pressure.

RECOMMENDED TIRE PRESSURE	
FRONT	REAR
1.58 [bar] / 23 [psi]	1.93 [bar] / 28 [psi]

Battery Charge Indicator

- The top LED on the System Controller flashes to indicate that the battery is being charged when the charger is connected to the charging port.
- The state of charge of the battery can also be checked on the LEDs of the battery itself.
- On the display, each ice-blue bar represents 20% capacity and each white bar represents 10% capacity. The top bar shows the maximum capacity. Example: Four ice-blue bars and one white bar are displayed. The state of charge is between 81% and 90%.
- If the capacity is low, both the lower bars change color. When the bottom two LEDs are orange there is 30-21%.
- If the bottom LED is the only one illuminated orange, the capacity is 20-11%.
- If the bottom LED is red, the capacity is 10% to reserve. And when flashing red it is between reserve and empty.



Establishing a Smartphone Connection

In order to use some of the eBike functions, a smartphone with the eBike Flow app is required. Download the Bosch eBike Flow app to your smartphone from the app store and follow the instructions on the app.



Connecting the Mini Remote to the System Controller

- The System Controller and Mini Remote operating units are connected via Bluetooth®. If the Mini Remote operating unit has not already been connected to the System Controller proceed as follows:
- When connecting a Mini Remote, go to settings then click on manage bike settings, then click on components, then click on add new device. Then follow app instructions.

Rim Magnet Speed Sensor

- The Shuttle AM features the Rim Magnet instead of a rotor magnet and wired speed sensor. The drive unit itself detects when the magnet is close to it and calculates the speed and any other data required.
- The Rim Magnet must be installed on the wheel for the motor to provide assist.
- Since the drive unit is sensitive to magnetic fields, avoid other magnetic fields in the vicinity of the drive unit (e.g. magnetic clipless pedals, magnetic cadence sensors, etc.) in order to prevent disruption to the drive unit.
- If you get a flat tire on a ride you will need a tube with at least a 32mm long valve stem to mount the rim magnet on.

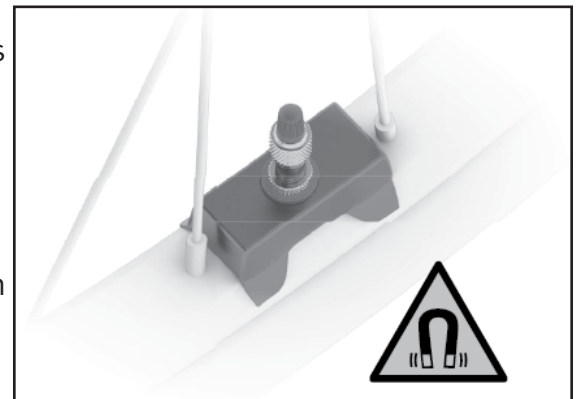

Riding Mode Customization

In the eBike Flow App you can adapt selected riding modes exactly to your needs: You can fine-tune riding modes so that they offer you more support or consume less power.

Display Options

Bosch offers a few different display options you can integrate with your Shuttle AM. Bosch also offers different mounts if you would like to use your smart phone as a display with the eBike Flow App.

eBike Lock

Using the eBike Flow App you can activate the eBike Lock feature for your Shuttle AM. The lock feature allows you to disable the assist and your smart phone works like a key to unlock your bike. The settings for this feature can be turned on, off, or adjusted in the settings of the eBike Flow App.

ConnectModule

The Shuttle AM is built to accommodate the ConnectModule. This unit can be added to your bike by your dealer. The ConnectModule features an audible alarm if your bike is moved. It also will send you a message alert if your bike is moved a lot. This unit also features GPS tracking so you will always know where your bike is.

System Updates

Like most modern devices, system improvements and features are developed over time. You can keep your Shuttle AM current with the latest updates through the eBike Flow App. In the app you can install the updates to your bike. You can also take your bike in to your local Pivot Dealer for them to install any updates.

Error Messages

The control unit shows whether critical errors or less critical errors occur in the eBike system. The error messages generated by the eBike system can be read via the eBike Flow app or by your Pivot dealer along with support for fix the error.

- The warning code will clear once the issue is resolved.
- If any issues persist after the suggestions below, contact your Pivot dealer.
- Less critical errors are shown by the assistance level LED flashing orange. Press the select button on the Mini Remote or mode button on the System Controller to confirm the error. The assistance level LED will once again continuously show the color of the set assistance level.
- Critical errors are shown by the assistance level LED and the battery charge indicator flashing red.

LESS CRITICAL ERRORS		CRITICAL ERRORS	
523005	The indicated error numbers show that there is interference with the speed sensor. See if you have lost the magnet while riding. Make sure your rim magnet does not have any magnetic interference in the vicinity of the drive unit. (magnetic pedals, cadence sensors, etc.)	660001	Do not charge the battery and do not continue to use! Please contact your Pivot dealer.
514001		660002	
514002		890000	Acknowledge the error code. Restart the system.
514003			If the problem persists: Acknowledge the error code. Perform a software update. Restart the system
514006			If the problem persists: Please contact your Pivot dealer.

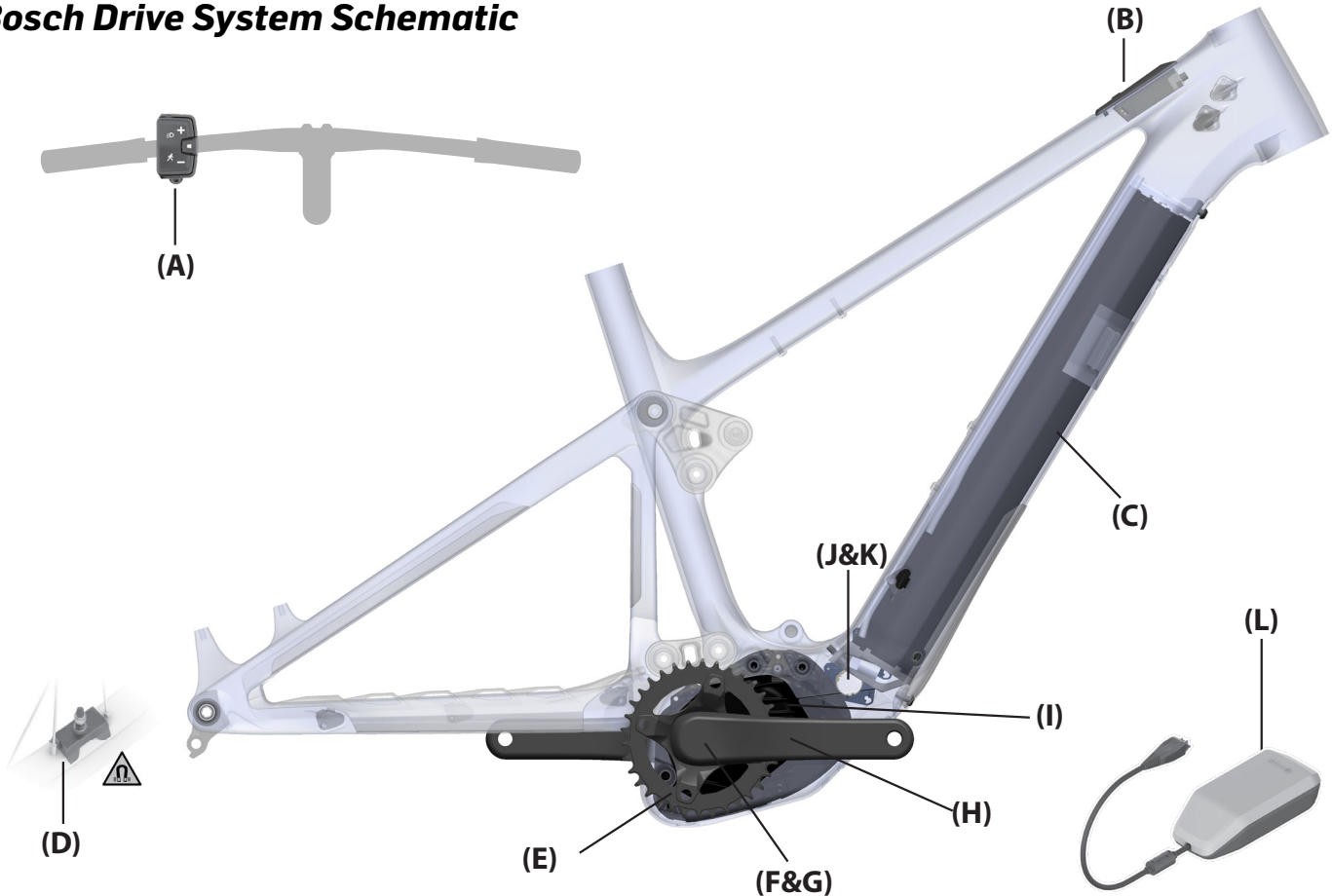
Bosch Drive System Schematic

LETTER	PART DESCRIPTION	PART NAME
A	Mini Remote	EB13.100.001
B	System Controller	EB13.100.000
C	PowerTube 750 Battery (US, CAN, JP, KOR)	EB12.100.00Z
	PowerTube 750 Battery (EU28, CH, NO, AUS, NZ)	EB12.100.00X
	PowerTube 625 Battery (Ride Level Builds US, CAN, JP, KOR)	EB12.100.013
	PowerTube 625 Battery (Ride Level Builds EU28, CH, NO, AUS, NZ)	EB12.100.011
D	Rim Magnet (Speed Sensor)	EB11.200.015
E	Spider & Chainring (Ride Builds)	ES-BSC-104-565-34T
	Spider & Chainring (Pro Builds)	ES-BSC-104-565/ 00.6218.034.003
	Spider & Chainring (Team Builds)	ES-BSC-104-565/ 00.6218.034.003
F&G	Drive Unit Lockring & O-Ring	1270.014.085/ 1270.016.119
H	Crank Arms (Ride Builds)	EC-1ISIS-160A
	Crank Arms (Pro Builds)	EC-1ISIS-160A
	Crank Arms (Team Builds)	EC-1ISIS-160CM
I	CX Performance Drive Unit	EB11.100.000
	CX Performance Race Edition Drive Unit	EB11.100.00G
J	Charging Socket & Cable	EB12.120.048
K	Charging Socket Cover	EB12.120.01B
L	Battery Charger 4A110V/Cable (US)	EB12.110.000/ 1270.020.343
	Battery Charger 4A 230V/Cable(EU)	EB12.110.001/ 1270.020.330
	Battery Charger 4A 230V/Cable(AUS)	EB12.110.001/ 1270.020.344
	Battery Charger 4A 230V/Cable(UK)	EB12.110.001/ 1270.020.331

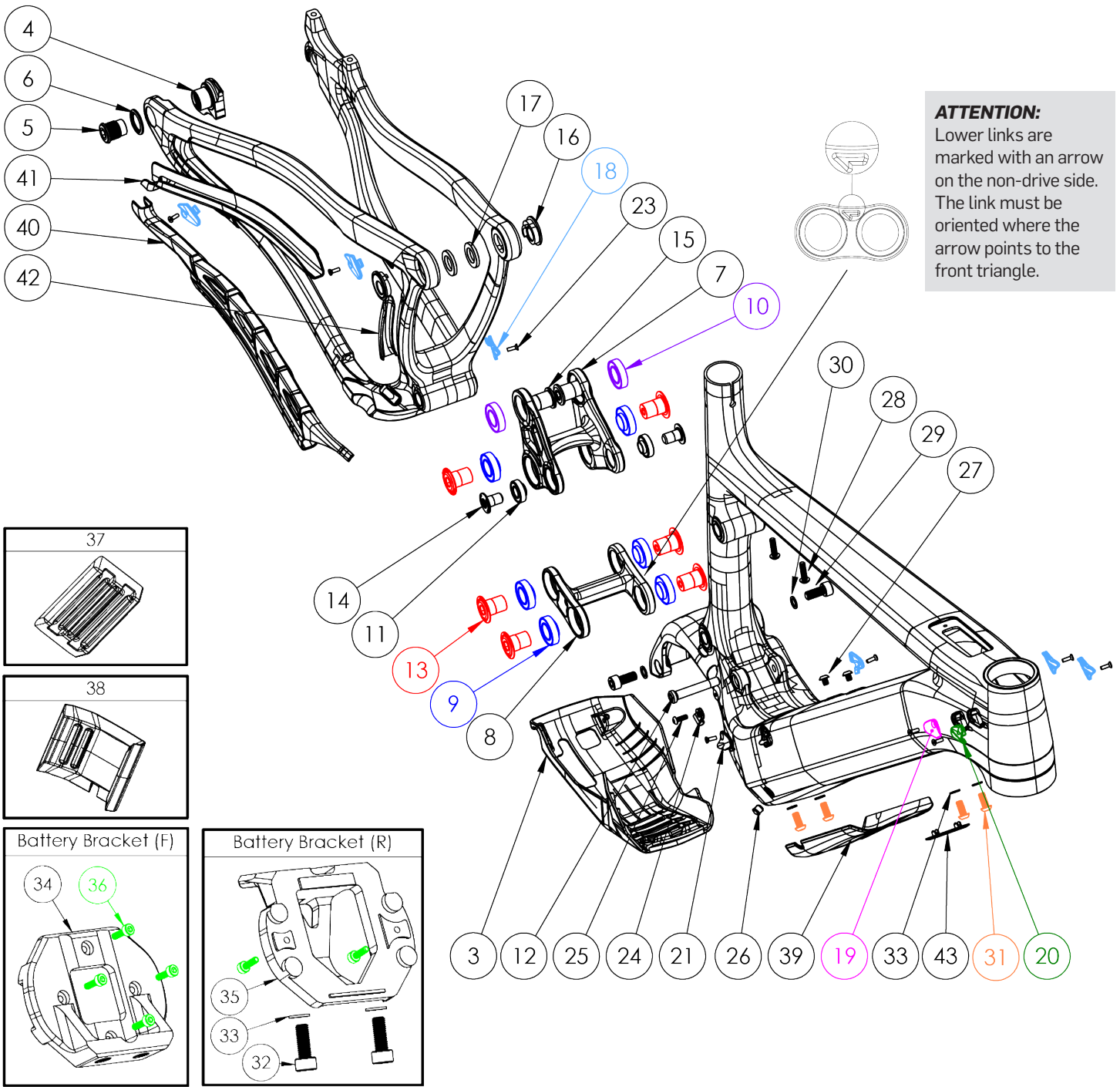
Small Parts Schematic

ATTENTION:
Lower links are marked with an arrow on the non-drive side. The link must be oriented where the arrow points to the front triangle.

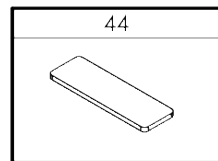
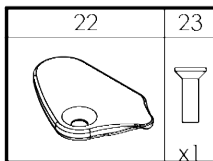
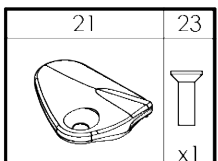
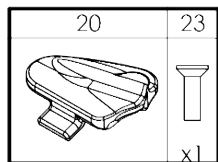
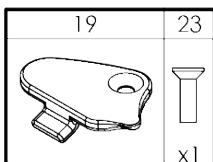
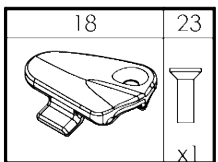
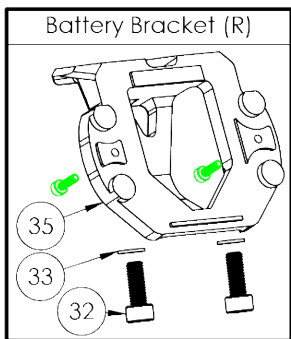
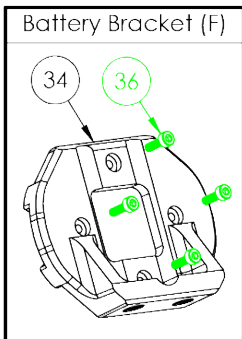
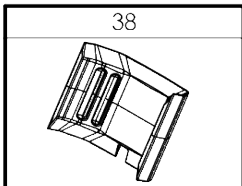
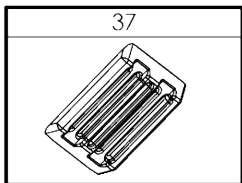



Hardware				
NUMBER	PART NUMBER	DESCRIPTION	TORQUE	*
3	FP-CVR-SKIDPLT-SHTV6-V1-R1	Shuttle V6 Skid Plate		
4	FP-UDH-TA-12MM-BLK-V1-R1	Universal Rear Derailleur Hanger		
5	-	Universal Rear Derailleur Hanger Bolt	25 Nm (18 lb-ft)	
6	-	Universal Rear Derailleur Hanger Washer		
7	FP-LNK-UL-68MM-V1-R1	68mm Upper Link		
8	FP-LNK-LL-50MM-V3-R1	50mm Out-to-Out Lower Link V3		
9	FP-BRG-6902-LLUMAXECN	28mm 6902 Extended Max-E Bearing		R
10	FP-BRG-6902-LLUMAX	28mm 6902 Standard Max Bearing		R
11	FP-BRG-6900-LLUMAXE	22mm 6900 Ext'd Max-E Bearing		R
12	FP-BLT-M8*45.7-BLK-V2	M8 Front Shock Bolt for 30.1mm Shock Spacing	13 Nm (10 lb-ft)	G / L
13	FP-BLT-M14*20-BLK-V2-R2	M14x20 Link Bolt	35 Nm (27 lb-ft)	L
14	FP-BLT-M10*16.5-BLK-V1	M10 Trunnion Mount Bolt	13 Nm (10 lb-ft)	L
15	FP-BLT-M14*20-BLK-V3-R2	M14x20 Flip Chip Bolt	35 Nm (27 lb-ft)	L
16	FP-NUT-FLIPCHIP-4.6MM-V1	4.6mm Flip Chip		G
17	FP-WSH-SPC-15I*250*3W	M14x3mm Flip Chip Spacer		G
18	FP-CLM-MECH-FRM-V1	Internal Routing Cable Clamp		
19	FP-CVR-MECH-FRM-V2	Internal Routing Hole Cover		
20	FP-CLM-DUAL-FRM-V1	Internal Routing Dual Clamp		
21	FP-CLM-MECH-FRM-V2	Internal Routing Cable Clamp (Mirrored)		
22	FP-CVR-MECH-FRM-V4	Internal Routing Cable Cap (Mirrored)		
23	FP-SCW-FLT-M3*10-BLK	CABLE PORT CLAMP SCREW BLACK		
24	FP-CLM-ADEL-V1-R1	Cable Routing Adel Clamp		
25	FP-SCW-BTN-M4*12-BLK-V1-R1	M4x12 Adel Clamp Mounting Bolt		
26	FP-PLG-DI2-7*8*5	7x8mm DI2 Plug Ext'd		
27	FP-BLT-BTN-M5*6-V1-R1	M5x6 DT Water Bottle Bolts	3 Nm (26 in-lb)	L
28	PIVOT WB BOLTS V2	Top Tube Tool Bolts		
29	FP-SCW-SCK-M8*18-R1-BLK	M8X18 SOCKET HEAD SCREW BLACK	13 Nm (10 lb-ft)	L
30	FP-WSH-8I*120*1W-BLK	M8 WASHER BLACK		
31	FP-SCW-BTN-M6*14-BLK-V1-R1	M6x14 Front Bracket/Skid Plate Bolts	6 Nm (53 in-lb)	L
32	FP-SCW-SCK-M6*16-BLK-V1-R1	M6x16 Rear Bracket Bolts	6 Nm (53 in-lb)	L
33	FP-WSH-M6-BLK-V1-R1	M6 Washer Black		
34	FP-MNT-FRNT-BATT-SLTV2-V1-R1	Front Battery Bracket		
35	FP-MNT-REAR-BATT-SLTV2-V1-R1	Rear Battery Bracket		
36	FP-BLT-SCK-M3*10-V1-R1	Battery Mounting Bolts	1 Nm (9 in-lb)	
37	FP-BATT-PAD-60*70-V1-R1	Upper Battery Pad		
38	FP-BATT-PAD-LWR-87.3MM-V1-R1	Lower Battery Pad		
39	FP-PRO-SHTV6-DT-V1-R1	SHTLv6 Downtube Protector		
40	FP-PRO-SHTV6-CS-V1-R1	SHTLv6 Chainstay Protector		
41	FP-PRO-SHTV6-SS-V1-R1	SHTLv6 Seatstay Protector		
42	FP-PRO-SHTV6-UR-V1-R1	SHTLv6 Upright Protector		
43	FP-PRO-LL-50MM-V3-R1	Lower Link Protector		
44	-	Frame Size Sticker		
Axles				
NUMBER	PART NUMBER	DESCRIPTION	TORQUE	*
101	157MM THROUGH AXLE V5	157mm UDH Rear Axle	15 Nm (11 lb-ft)	G
102				
Bike Care				
*	PRODUCT TYPE	RECOMMENDED PRODUCT	TORQUE	*
G	Grease	Motorex Bike Grease 2000		
L	Thread Locker**	Loctite Thread Locker #243 (or equivalent)		
G/L	Grease (Bolt Shaft) Thread Locker (Bolt Threads)	See Above	25 Nm (18 lb-ft)	
A	Anti-Seize	Motorex Copper Paste		
R	Retaining Compound	Loctite Retaining Compound #620 (or equivalent)		

**Threadlocker should always be applied to the corresponding female threads for the bolt specified



Shuttle AM Wiring Diagram

- The diagrams below will help illustrate how the wires are to be routed through the internal cable guides.
- The routing shown below will help minimize the likelihood of pinching a wire when removing and installing the motor for maintenance purposes.

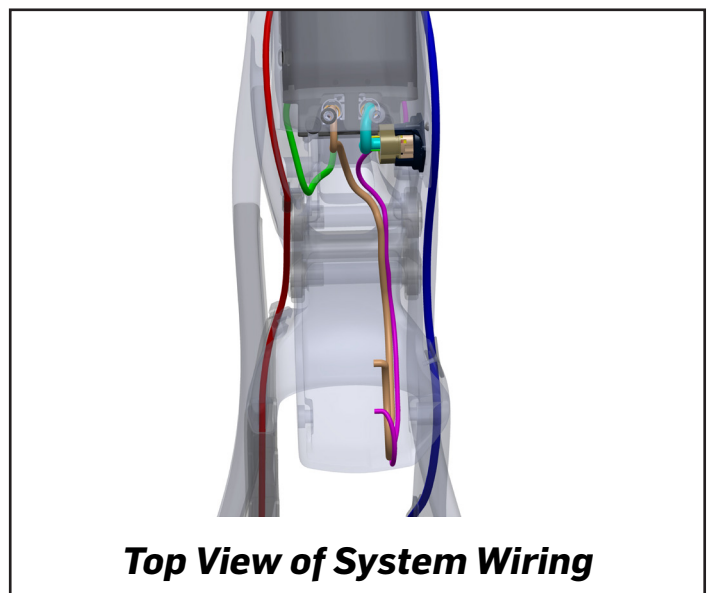
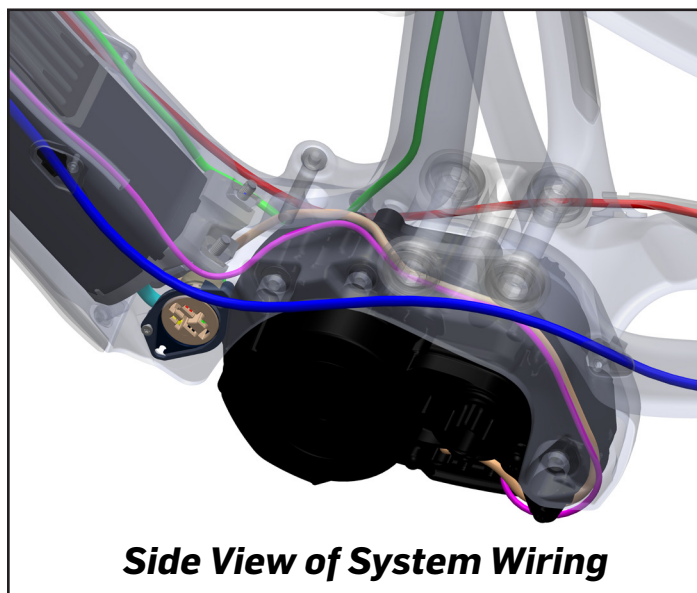
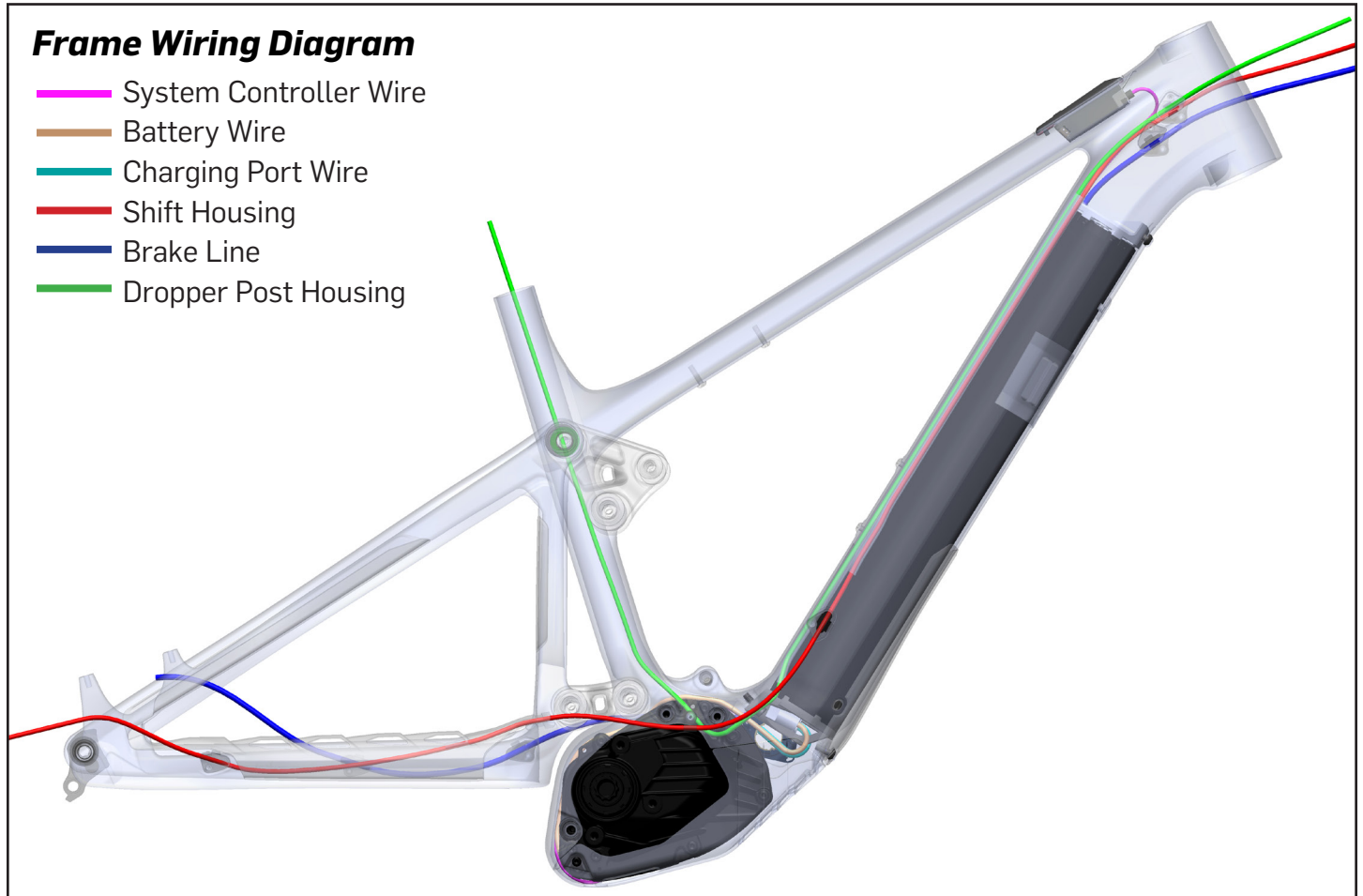

Bicycle Safety

This bike is not designed or equipped for use on public roads. Before it can be used on public roads it must be fitted with the legally prescribed equipment. It is designed to be used off-road, but not for competitions. The manufacturer and dealer accept no liability for damage resulting from any use beyond this definition and/or failure to comply with the safety information and instructions in this user guide. This applies particularly to, but not limited to, the use of this bike in competitions, overloading, and the failure to properly rectify faults. Intended use also includes conformance with the specified operating, service, and repair conditions in the user guide. Fluctuations in the consumption and power of the battery and a reduction of capacity with increasing age are common and technically unavoidable, and as such, do not constitute material defects.

Battery Safety

- Refer to the current Bosch battery manual from safety and care instructions before use.
- Batteries are subject to the dangerous goods regulations. Private users are permitted to transport them on the road without further conditions. If transported by commercial third parties (e.g. by air freight, logistics companies, or postal service) special conditions apply to packing and labeling. For questions about transporting batteries, please contact your local Pivot dealer.
- Damaged batteries must not be charged, used, or transported. They can explode and cause serious burns or fires. Gases can be released and irritate the airways. Ensure there is a supply of fresh air and consult a doctor in the event of discomfort. Liquid can escape and cause skin irritation. Avoid contact with this liquid, but in case of accidental contact, wash off with water. If the liquid gets into the eyes, flush out with water and seek medical attention.
- Batteries must not be submerged in water. There is a risk of explosion. Do not attempt to extinguish a burning battery with water, only the surrounding burning material. For burning batteries, use a Class D Fire Extinguisher. If it is possible to take the battery safely outside, smother the fire with sand. You do not need to worry that you are in danger when riding in the rain; the battery is protected from moisture and condensation.
- Clean the battery with a dry or, if at all, a slightly moist rag. Do not direct the water jet of a high pressure cleaner at the rechargeable battery or submerge the battery into water, as there is a risk of water entry and/or short-circuit.
- For more information on the proper handling of your rechargeable battery see the system instructions of your drive manufacturer.
- Charge your battery only with the supplied charger. Do not use the charger of any other manufacturer, not even when the connector of the charger matches your rechargeable battery. The rechargeable battery can heat up, catch fire or even explode!
- Keep the rechargeable battery and the charger out of the reach of children!
- We recommend that you charge your battery only during the day and only in dry rooms which have a smoke or a fire detector; but not in your bedroom. Place the battery during the charging process on a big, non-inflammable plate made of ceramics or glass! Unplug the battery once it has been charged up.
- Keep the rechargeable battery and the charger away from moisture and water during the charging process to exclude electric shocks and short circuits.
- Do not use a rechargeable battery or a charger that is defective. If you are in doubt or if you have any questions, contact your Pivot dealer.
- Do not expose your battery or the charger to the blazing sun during charging.
- Do not charge any other electrical devices with the supplied charger of your Pivot e-bike.
- The drive is not approved for steam cleaning, high-pressure cleaning or cleaning with a water hose. The contact of the electronics or the drive with water can destroy the units. The individual drive components can be cleaned with a soft rag and neutral detergents. You may use a moist rag, but not excessive water. Keep the rechargeable battery dry and do not submerge it. Risk of explosion.
- Make sure your rechargeable battery does not show any damage, i.e. cracks, breakages or discolorations at the contact points. Do not use a battery with such damage. Bring a damaged battery to your Pivot dealer at once.

Battery Safety (Continued)

- Make sure your rechargeable battery is in sound condition. Do not open, disassemble or crush the battery. Risk of explosion!
- Make sure your rechargeable battery is not exposed to mechanical impacts.
- Keep your battery away from fire and heat. Risk of explosion!
- Batteries must not be short-circuited. Therefore store them in a safe storage area and make sure the battery is not short-circuited accidentally (e.g. with metal or another battery). In addition, rechargeable batteries must not be stored inappropriately, e.g. in a box or in a drawer where they can be short-circuited by other conductive materials or where they can short-circuit each other. Do not deposit any objects in the storage area (e.g. clothes).
- Make sure to use the battery only for the Pivot e-bike for which it is designed.
- Remove the rechargeable battery if you do not use your Pivot e-bike for a long period of time (e.g. during the winter season). Store the rechargeable battery in a dry room at temperatures between 5 - 20°C (41 - 68°F) . The state of charge should be 50 - 70% of the charging capacity. Check the state of charge if the rechargeable battery is left unused for more than two months and recharge it in between, if necessary, to 50%.
- The battery does not come charged and must be charged completely before the first use.
- When removing the charger from the outlet or the port, pull on the plug, not the cord.
- When charging the battery, plug the cord into the wall outlet first, and then into the battery.
- Be sure that the charger is on a flat and stable surface, when charging.
- Do not leave the battery fully depleted for an extended period of time. This will cause the battery to deteriorate and reduce the battery capacity.
- Keep the rechargeable battery and the charger away from moisture and water during the charging process to avoid electric shocks and short circuits.
- Keep the charger and battery out of reach of children.
- Do not use a battery or a charger that is defective. If you are in doubt, contact your Pivot dealer.
- If the rechargeable battery or the charger (or parts of it) must be replaced, only use original spare parts. Contact your Pivot dealer.
- Charge the battery at an ambient temperature of approximately 20°C (68°F). Therefore, before starting the charging, wait until the temperature of the battery has increased or decreased after a ride in cold or hot weather.
- Do not dispose of your rechargeable battery in the normal household rubbish! It must be disposed of according to battery disposal regulations. Therefore, sellers of new rechargeable batteries must provide collection of old batteries and appropriate disposal. If you are in doubt or if you have any questions, contact your Pivot dealer.
- When the battery is fully charged, remove the charger.
- Observe the notes on the respective labels on the rechargeable battery or on the charger.

SOURCES

Bosch Performance CX Drive System

Additional information regarding safety, operation, functionality of the Bosch Performance CX Drive System, its components, software and mobile apps can be found on their website by scanning the QR code to the right.



Bosch

Pivot Shuttle AM

For FAQs and additional technical documents regarding the maintenance of the Pivot Shuttle AM can be found on by scanning the QR code to the right.



Pivot

Battery Recycling Information

Pivot is a proud partner of the Call2Recycle battery recycling program. When you are ready to replace your battery, your local Pivot dealer can take care of properly shipping your battery to be recycled.





6720 South Clementine Court
Tempe, AZ 85283

T +1 480 467 2920
info@pivotcycles.com
www.pivotcycles.com
